



- 1. Ecrú (Sul:1082)
- 2. Off White (Sul:1071)
- 3. Ecrú (Sul:1082)
- 4. Off White (Sul:1071)
- 5. Ecrú (Sul:1082)

Gfe-Csw-1-1.
1.74x2.60 inches; 2,520 stitches
5 thread changes; 2 colors



- 1. Ecrú (Sul:1082)
- 2. Off White (Sul:1071)
- 3. Ecrú (Sul:1082)

Gfe-Csw-1-10.
2.92x1.72 inches; 3,647 stitches
3 thread changes; 2 colors



- 1. Off White (Sul:1071)
- 2. Ecrú (Sul:1082)
- 3. Off White (Sul:1071)
- 4. Ecrú (Sul:1082)
- 5. Off White (Sul:1071)

Gfe-Csw-1-11.
3.76x1.01 inches; 7,467 stitches
5 thread changes; 2 colors



- 1. Off White (Sul:1071)
- 2. Ecrú (Sul:1082)
- 3. Off White (Sul:1071)

Gfe-Csw-1-12.
1.48x2.57 inches; 4,054 stitches
3 thread changes; 2 colors



- 1. Off White (Sul:1071)
- 2. Ecrú (Sul:1082)
- 3. Off White (Sul:1071)
- 4. Ecrú (Sul:1082)

Gfe-Csw-1-13.
3.12x1.88 inches; 4,096 stitches
4 thread changes; 2 colors



- 1. Off White (Sul:1071)
- 2. Ecrú (Sul:1082)

Gfe-Csw-1-14.
3.77x1.36 inches; 3,413 stitches
2 thread changes; 2 colors



- 1. Ecrú (Sul:1082)
- 2. Off White (Sul:1071)
- 3. Ecrú (Sul:1082)
- 4. Off White (Sul:1071)
- 5. Ecrú (Sul:1082)

Gfe-Csw-1-15.
2.49x3.31 inches; 4,181 stitches
5 thread changes; 2 colors



- 1. Off White (Sul:1071)
- 2. Ecrú (Sul:1082)
- 3. Off White (Sul:1071)

Gfe-Csw-1-16.
2.04x1.95 inches; 4,261 stitches
3 thread changes; 2 colors

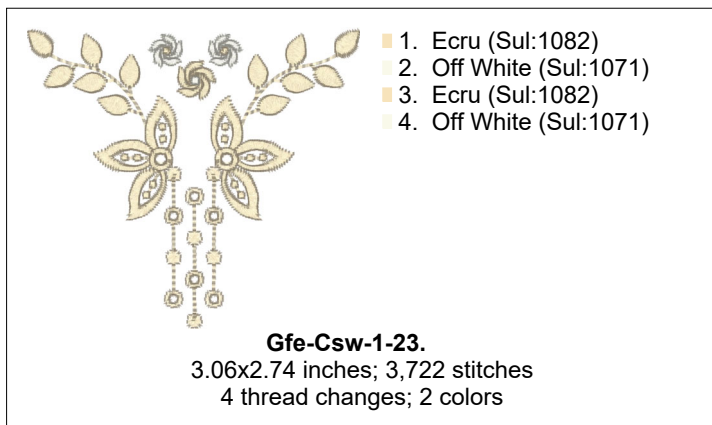
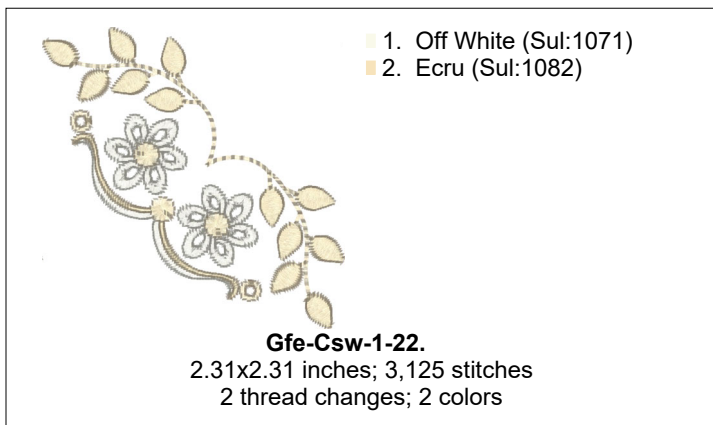
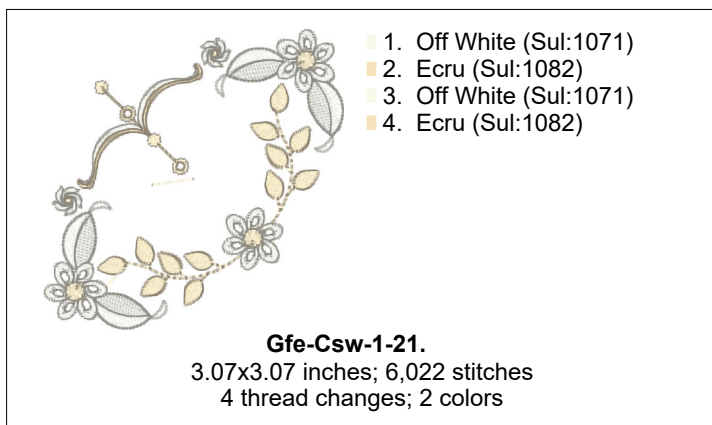
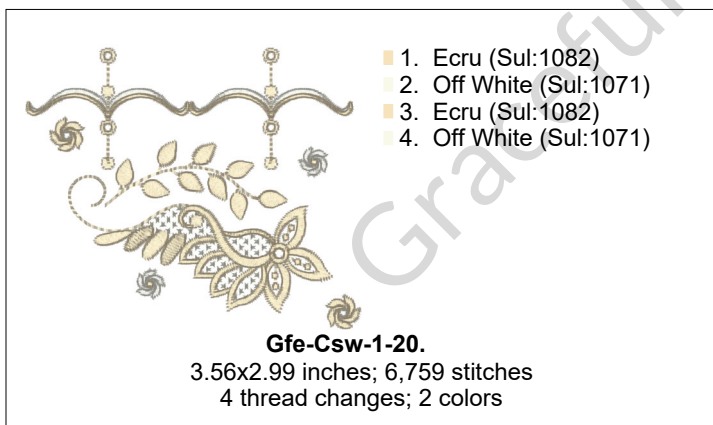
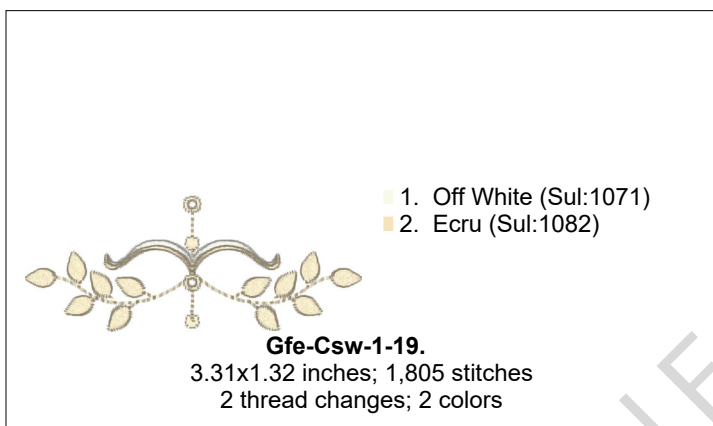
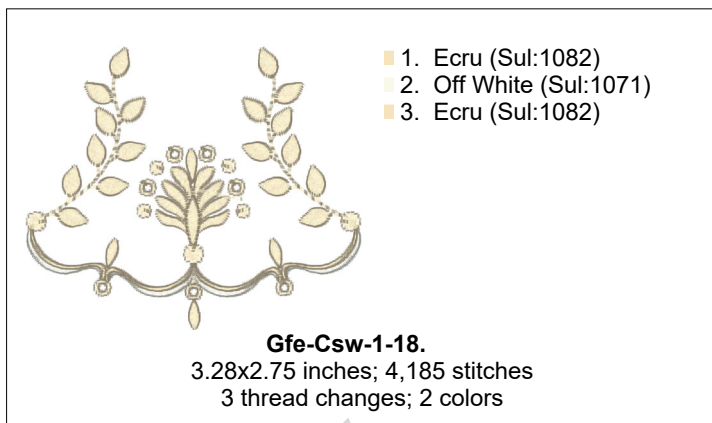
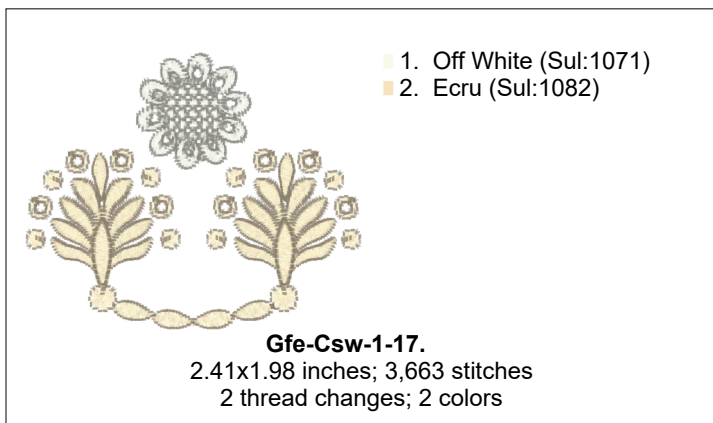

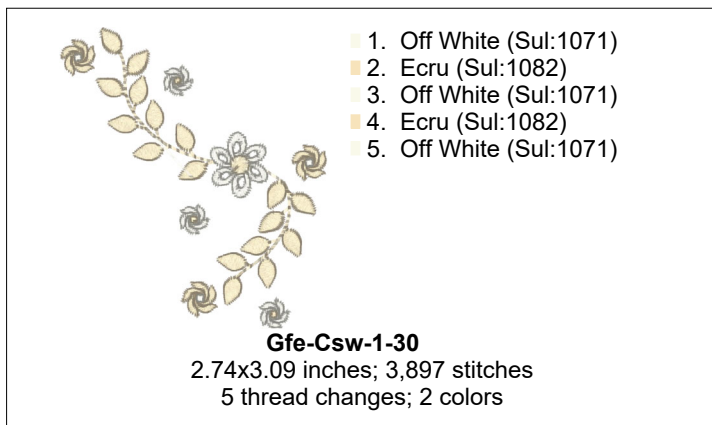
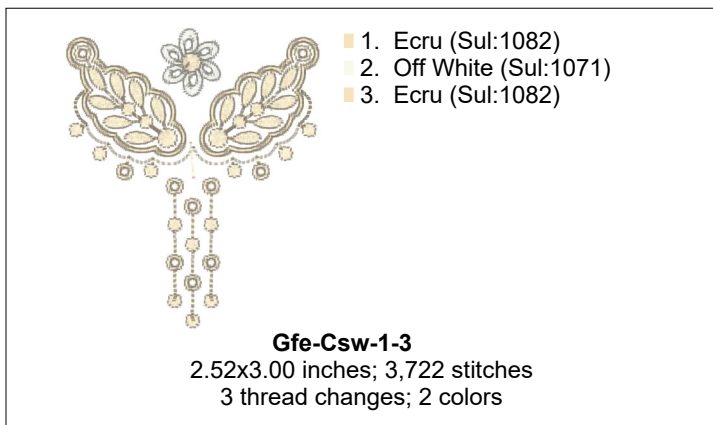
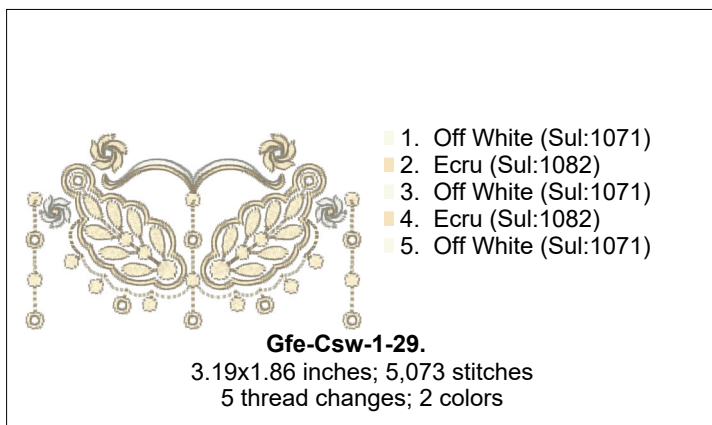
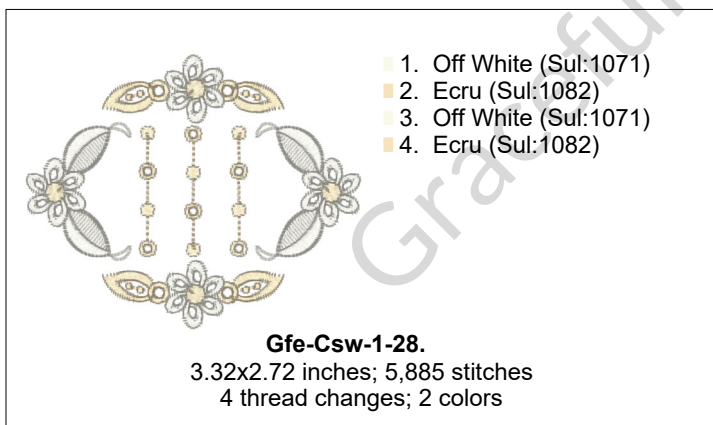
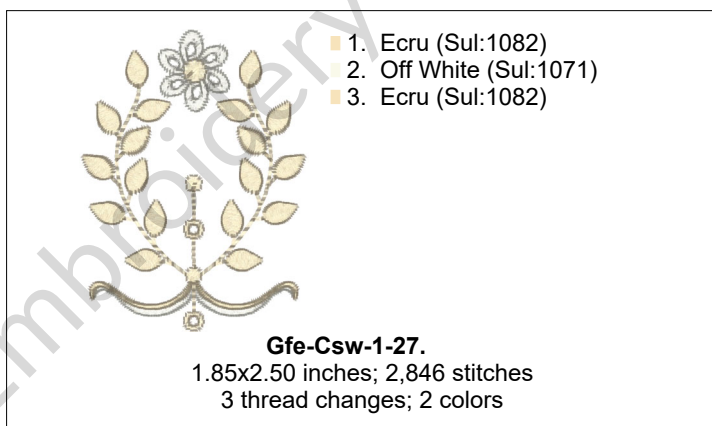
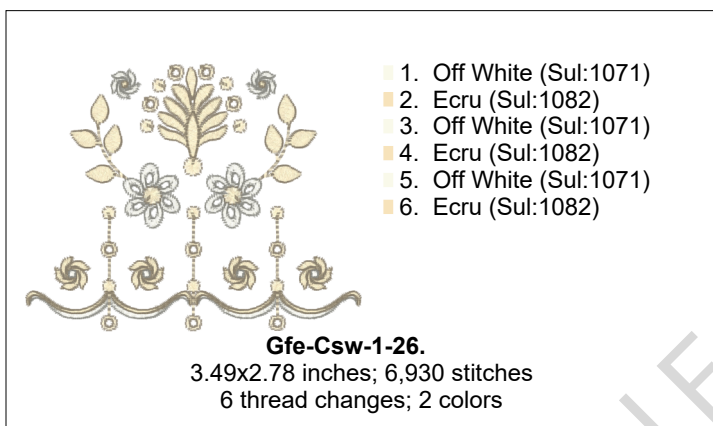
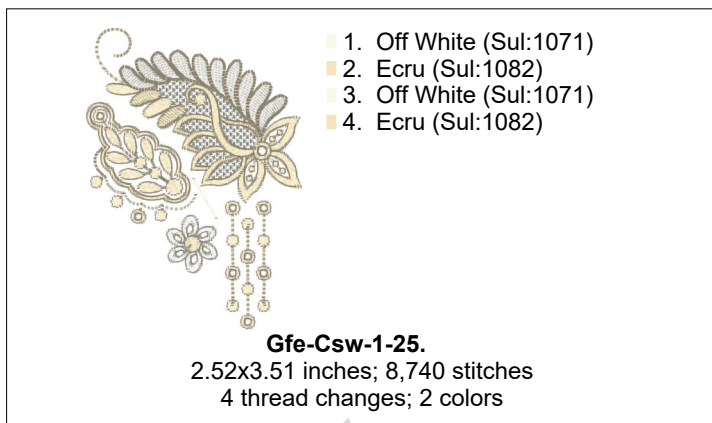
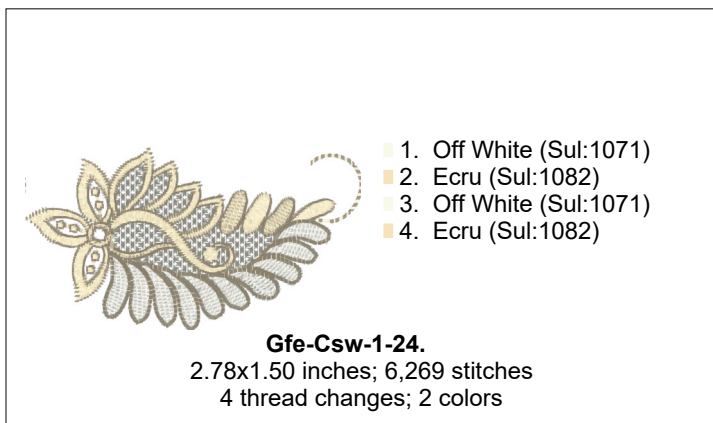



- 1. Off White (Sul:1071)
- 2. Ecrú (Sul:1082)
- 3. Off White (Sul:1071)
- 4. Ecrú (Sul:1082)

Gfe-Csw-1-31.

1.99x3.42 inches; 5,003 stitches
4 thread changes; 2 colors



- 1. Off White (Sul:1071)
- 2. Ecrú (Sul:1082)

Gfe-Csw-1-32.

1.35x3.72 inches; 6,202 stitches
2 thread changes; 2 colors



- 1. Ecrú (Sul:1082)
- 2. Off White (Sul:1071)
- 3. Ecrú (Sul:1082)

Gfe-Csw-1-33.

3.63x2.70 inches; 8,233 stitches
3 thread changes; 2 colors

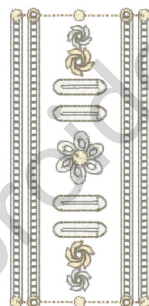

- 1. Ecrú (Sul:1082)
- 2. Off White (Sul:1071)
- 3. Ecrú (Sul:1082)
- 4. Off White (Sul:1071)

Gfe-Csw-1-34.

1.78x3.80 inches; 13,283 stitches
4 thread changes; 2 colors

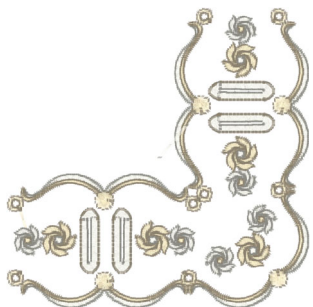

- 1. Ecrú (Sul:1082)
- 2. Off White (Sul:1071)
- 3. Ecrú (Sul:1082)
- 4. Off White (Sul:1071)
- 5. Ecrú (Sul:1082)
- 6. Off White (Sul:1071)

Gfe-Csw-1-35.

3.13x3.12 inches; 8,539 stitches
6 thread changes; 2 colors



- 1. Ecrú (Sul:1082)
- 2. Off White (Sul:1071)
- 3. Ecrú (Sul:1082)
- 4. Off White (Sul:1071)

Gfe-Csw-1-36

3.30x2.52 inches; 5,715 stitches
4 thread changes; 2 colors



- 1. Ecrú (Sul:1082)
- 2. Off White (Sul:1071)
- 3. Ecrú (Sul:1082)

Gfe-Csw-1-4.

2.70x1.15 inches; 1,664 stitches
3 thread changes; 2 colors



- 1. Ecrú (Sul:1082)
- 2. Off White (Sul:1071)

Gfe-Csw-1-5.

1.85x1.83 inches; 5,042 stitches
2 thread changes; 2 colors

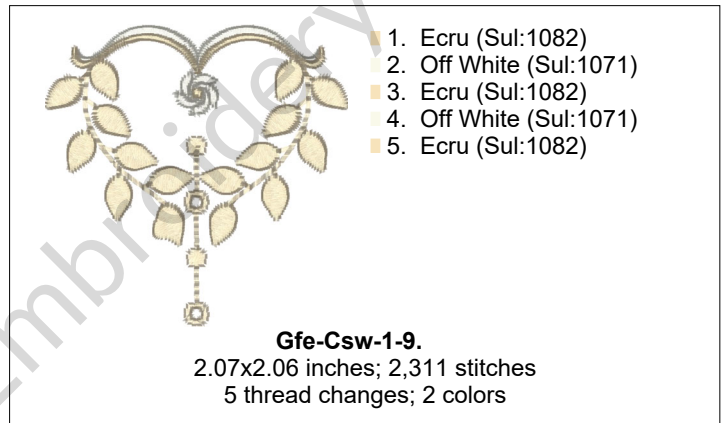
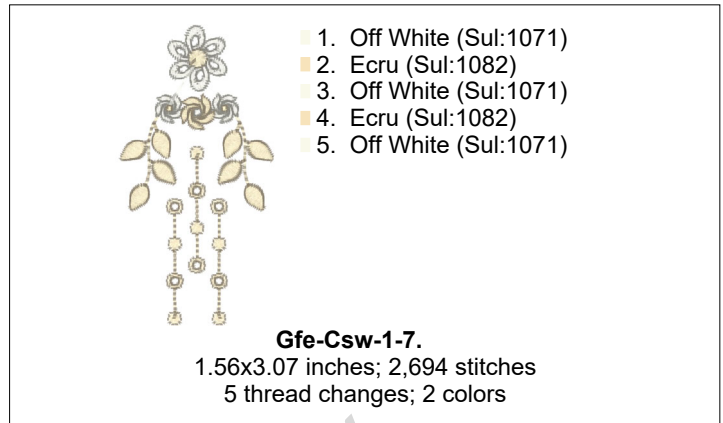
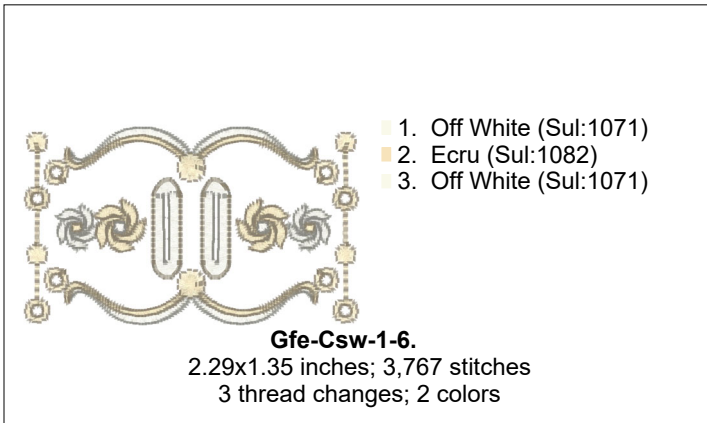



- 1. Ecrú (Sul:1082)
- 2. Off White (Sul:1071)
- 3. Ecrú (Sul:1082)
- 4. Off White (Sul:1071)
- 5. Ecrú (Sul:1082)

Gfe-Csw-2-1.

3.67x5.21 inches; 8,417 stitches
5 thread changes; 2 colors



- 1. Ecrú (Sul:1082)
- 2. Off White (Sul:1071)
- 3. Ecrú (Sul:1082)
- 4. Off White (Sul:1071)
- 5. Ecrú (Sul:1082)

Gfe-Csw-2-10.

2.02x6.51 inches; 10,456 stitches
5 thread changes; 2 colors

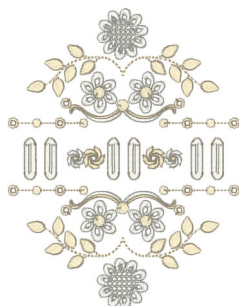

- 1. Off White (Sul:1071)
- 2. Ecrú (Sul:1082)
- 3. Off White (Sul:1071)

Gfe-Csw-2-11.

3.77x4.90 inches; 13,217 stitches
3 thread changes; 2 colors



- 1. Ecrú (Sul:1082)
- 2. Off White (Sul:1071)
- 3. Ecrú (Sul:1082)
- 4. Off White (Sul:1071)

Gfe-Csw-2-12.

3.64x6.88 inches; 13,354 stitches
4 thread changes; 2 colors



- 1. Off White (Sul:1071)
- 2. Ecrú (Sul:1082)

Gfe-Csw-2-13.

3.29x5.61 inches; 9,612 stitches
2 thread changes; 2 colors

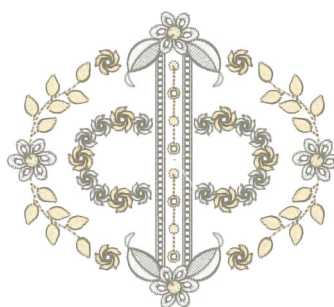

- 1. Ecrú (Sul:1082)
- 2. Off White (Sul:1071)
- 3. Ecrú (Sul:1082)
- 4. Off White (Sul:1071)

Gfe-Csw-2-14.

4.62x4.10 inches; 17,998 stitches
4 thread changes; 2 colors



- 1. Off White (Sul:1071)
- 2. Ecrú (Sul:1082)
- 3. Off White (Sul:1071)
- 4. Ecrú (Sul:1082)

Gfe-Csw-2-15.

4.80x6.97 inches; 23,990 stitches
4 thread changes; 2 colors



- 1. Off White (Sul:1071)
- 2. Ecrú (Sul:1082)
- 3. Off White (Sul:1071)
- 4. Ecrú (Sul:1082)

Gfe-Csw-2-16.

1.35x5.13 inches; 10,071 stitches
4 thread changes; 2 colors



- 1. Off White (Sul:1071)
- 2. Ecrú (Sul:1082)
- 3. Off White (Sul:1071)
- 4. Ecrú (Sul:1082)
- 5. Off White (Sul:1071)
- 6. Ecrú (Sul:1082)

Gfe-Csw-2-17.
2.89x6.80 inches; 28,976 stitches
6 thread changes; 2 colors



- 1. Ecrú (Sul:1082)
- 2. Off White (Sul:1071)
- 3. Ecrú (Sul:1082)
- 4. Off White (Sul:1071)
- 5. Ecrú (Sul:1082)

Gfe-Csw-2-18.
3.69x4.13 inches; 5,870 stitches
5 thread changes; 2 colors



- 1. Off White (Sul:1071)
- 2. Ecrú (Sul:1082)
- 3. Off White (Sul:1071)
- 4. Ecrú (Sul:1082)

Gfe-Csw-2-19.
3.37x6.36 inches; 12,195 stitches
4 thread changes; 2 colors



- 1. Off White (Sul:1071)
- 2. Ecrú (Sul:1082)
- 3. Off White (Sul:1071)
- 4. Ecrú (Sul:1082)
- 5. Off White (Sul:1071)

Gfe-Csw-2-2.
3.76x4.78 inches; 21,055 stitches
5 thread changes; 2 colors



- 1. Ecrú (Sul:1082)
- 2. Off White (Sul:1071)
- 3. Ecrú (Sul:1082)
- 4. Off White (Sul:1071)
- 5. Ecrú (Sul:1082)
- 6. Off White (Sul:1071)
- 7. Ecrú (Sul:1082)

Gfe-Csw-2-20.
4.28x4.91 inches; 13,655 stitches
7 thread changes; 2 colors



- 1. Off White (Sul:1071)
- 2. Ecrú (Sul:1082)
- 3. Off White (Sul:1071)
- 4. Ecrú (Sul:1082)
- 5. Off White (Sul:1071)

Gfe-Csw-2-21.
4.63x6.57 inches; 10,730 stitches
5 thread changes; 2 colors



- 1. Ecrú (Sul:1082)
- 2. Off White (Sul:1071)
- 3. Ecrú (Sul:1082)
- 4. Off White (Sul:1071)

Gfe-Csw-2-22.
4.80x6.68 inches; 11,492 stitches
4 thread changes; 2 colors



- 1. Off White (Sul:1071)
- 2. Ecrú (Sul:1082)
- 3. Off White (Sul:1071)
- 4. Ecrú (Sul:1082)

Gfe-Csw-2-3.
4.76x2.31 inches; 6,248 stitches
4 thread changes; 2 colors



- 1. Ecrú (Sul:1082)
- 2. Off White (Sul:1071)
- 3. Ecrú (Sul:1082)
- 4. Off White (Sul:1071)
- 5. Ecrú (Sul:1082)
- 6. Off White (Sul:1071)

Gfe-Csw-2-4.
3.12x5.14 inches; 12,342 stitches
6 thread changes; 2 colors



- 1. Off White (Sul:1071)
- 2. Ecrú (Sul:1082)
- 3. Off White (Sul:1071)
- 4. Ecrú (Sul:1082)
- 5. Off White (Sul:1071)

Gfe-Csw-2-5.
3.84x5.18 inches; 10,264 stitches
5 thread changes; 2 colors



- 1. Off White (Sul:1071)
- 2. Ecrú (Sul:1082)
- 3. Off White (Sul:1071)
- 4. Ecrú (Sul:1082)
- 5. Off White (Sul:1071)

Gfe-Csw-2-6.
3.39x4.20 inches; 9,537 stitches
5 thread changes; 2 colors



- 1. Off White (Sul:1071)
- 2. Ecrú (Sul:1082)
- 3. Off White (Sul:1071)
- 4. Ecrú (Sul:1082)

Gfe-Csw-2-7.
3.17x5.48 inches; 7,273 stitches
4 thread changes; 2 colors



- 1. Ecrú (Sul:1082)
- 2. Off White (Sul:1071)
- 3. Ecrú (Sul:1082)
- 4. Off White (Sul:1071)

Gfe-Csw-2-8.
4.12x3.63 inches; 10,139 stitches
4 thread changes; 2 colors



- 1. Off White (Sul:1071)
- 2. Ecrú (Sul:1082)

Gfe-Csw-2-9.
2.13x4.20 inches; 5,514 stitches
2 thread changes; 2 colors



- 1. Ecrú (Sul:1082)
- 2. Off White (Sul:1071)
- 3. Ecrú (Sul:1082)

Gfe-Csw-3-1.
3.63x9.28 inches; 22,579 stitches
3 thread changes; 2 colors

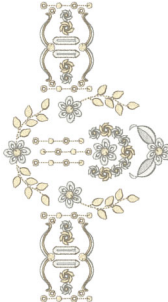

- 1. Ecrú (Sul:1082)
- 2. Off White (Sul:1071)
- 3. Ecrú (Sul:1082)
- 4. Off White (Sul:1071)
- 5. Ecrú (Sul:1082)
- 6. Off White (Sul:1071)

Gfe-Csw-3-10.
4.20x7.59 inches; 17,049 stitches
6 thread changes; 2 colors



- 1. Ecrú (Sul:1082)
- 2. Off White (Sul:1071)
- 3. Ecrú (Sul:1082)
- 4. Off White (Sul:1071)
- 5. Ecrú (Sul:1082)

Gfe-Csw-3-11.
5.65x9.27 inches; 26,265 stitches
5 thread changes; 2 colors



- 1. Off White (Sul:1071)
- 2. Ecrú (Sul:1082)
- 3. Off White (Sul:1071)
- 4. Ecrú (Sul:1082)
- 5. Off White (Sul:1071)

Gfe-Csw-3-12.
4.41x8.97 inches; 46,685 stitches
5 thread changes; 2 colors



- 1. Off White (Sul:1071)
- 2. Ecrú (Sul:1082)
- 3. Off White (Sul:1071)
- 4. Ecrú (Sul:1082)

Gfe-Csw-3-13.
2.89x7.71 inches; 9,150 stitches
4 thread changes; 2 colors



- 1. Ecrú (Sul:1082)
- 2. Off White (Sul:1071)
- 3. Ecrú (Sul:1082)
- 4. Off White (Sul:1071)

Gfe-Csw-3-14.
5.71x5.85 inches; 14,765 stitches
4 thread changes; 2 colors



- 1. Off White (Sul:1071)
- 2. Ecrú (Sul:1082)
- 3. Off White (Sul:1071)
- 4. Ecrú (Sul:1082)

Gfe-Csw-3-2.
3.31x9.06 inches; 42,044 stitches
4 thread changes; 2 colors



- 1. Off White (Sul:1071)
- 2. Ecrú (Sul:1082)
- 3. Off White (Sul:1071)
- 4. Ecrú (Sul:1082)
- 5. Off White (Sul:1071)

Gfe-Csw-3-3.
5.45x8.93 inches; 29,706 stitches
5 thread changes; 2 colors



- 1. Off White (Sul:1071)
- 2. Ecu (Sul:1082)

Gfe-Csw-3-4
5.39x7.72 inches; 22,107 stitches
2 thread changes; 2 colors



- 1. Off White (Sul:1071)
- 2. Ecu (Sul:1082)
- 3. Off White (Sul:1071)
- 4. Ecu (Sul:1082)

Gfe-Csw-3-5.
5.07x8.98 inches; 20,650 stitches
4 thread changes; 2 colors



- 1. Ecu (Sul:1082)
- 2. Off White (Sul:1071)
- 3. Ecu (Sul:1082)
- 4. Off White (Sul:1071)

Gfe-Csw-3-6.
5.38x8.95 inches; 30,697 stitches
4 thread changes; 2 colors



- 1. Off White (Sul:1071)
- 2. Ecu (Sul:1082)
- 3. Off White (Sul:1071)
- 4. Ecu (Sul:1082)
- 5. Off White (Sul:1071)

Gfe-Csw-3-7.
4.79x9.17 inches; 27,542 stitches
5 thread changes; 2 colors



- 1. Off White (Sul:1071)
- 2. Ecu (Sul:1082)
- 3. Off White (Sul:1071)
- 4. Ecu (Sul:1082)
- 5. Off White (Sul:1071)

Gfe-Csw-3-8.
5.50x7.56 inches; 21,587 stitches
5 thread changes; 2 colors



- 1. Off White (Sul:1071)
- 2. Ecu (Sul:1082)
- 3. Off White (Sul:1071)
- 4. Ecu (Sul:1082)

Gfe-Csw-3-9.
5.63x8.40 inches; 41,803 stitches
4 thread changes; 2 colors

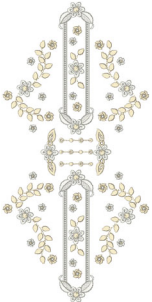

- 1. Off White (Sul:1071)
- 2. Ecrú (Sul:1082)
- 3. Off White (Sul:1071)
- 4. Ecrú (Sul:1082)
- 5. Off White (Sul:1071)

Gfe-Csw-4-1
5.66x11.63 inches; 38,712 stitches
5 thread changes; 2 colors



- 1. Ecrú (Sul:1082)
- 2. Off White (Sul:1071)
- 3. Ecrú (Sul:1082)
- 4. Off White (Sul:1071)

Gfe-Csw-4-10
7.63x11.57 inches; 25,896 stitches
4 thread changes; 2 colors



- 1. Off White (Sul:1071)
- 2. Ecrú (Sul:1082)

Gfe-Csw-4-11
5.39x11.69 inches; 25,634 stitches
2 thread changes; 2 colors



- 1. Off White (Sul:1071)
- 2. Ecrú (Sul:1082)
- 3. Off White (Sul:1071)
- 4. Ecrú (Sul:1082)
- 5. Off White (Sul:1071)

Gfe-Csw-4-12
7.35x7.82 inches; 15,206 stitches
5 thread changes; 2 colors



- 1. Ecrú (Sul:1082)
- 2. Off White (Sul:1071)
- 3. Ecrú (Sul:1082)
- 4. Off White (Sul:1071)
- 5. Ecrú (Sul:1082)
- 6. Off White (Sul:1071)

Gfe-Csw-4-2.
7.63x10.41 inches; 32,493 stitches
6 thread changes; 2 colors



- 1. Off White (Sul:1071)
- 2. Ecrú (Sul:1082)
- 3. Off White (Sul:1071)
- 4. Ecrú (Sul:1082)
- 5. Off White (Sul:1071)

Gfe-Csw-4-3
6.44x10.80 inches; 47,094 stitches
5 thread changes; 2 colors

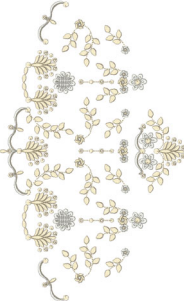

- 1. Ecrú (Sul:1082)
- 2. Off White (Sul:1071)
- 3. Ecrú (Sul:1082)
- 4. Off White (Sul:1071)

Gfe-Csw-4-4.
6.93x11.26 inches; 29,604 stitches
4 thread changes; 2 colors



- 1. Ecrú (Sul:1082)
- 2. Off White (Sul:1071)
- 3. Ecrú (Sul:1082)
- 4. Off White (Sul:1071)
- 5. Ecrú (Sul:1082)

Gfe-Csw-4-5.
7.23x11.55 inches; 38,622 stitches
5 thread changes; 2 colors

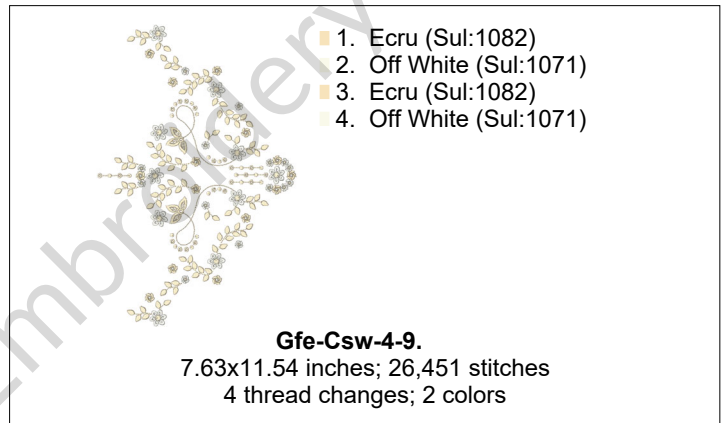
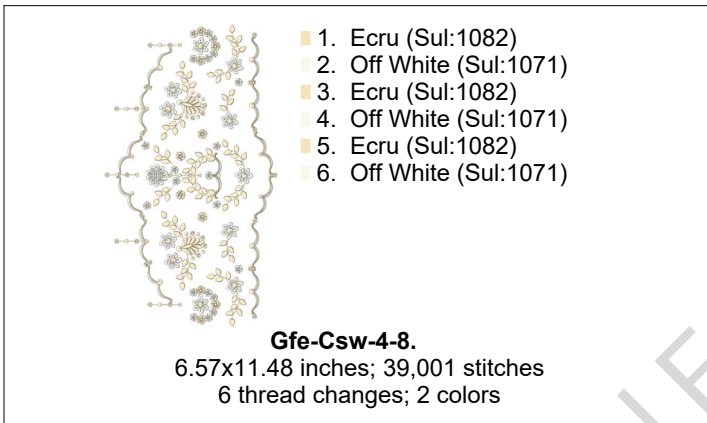
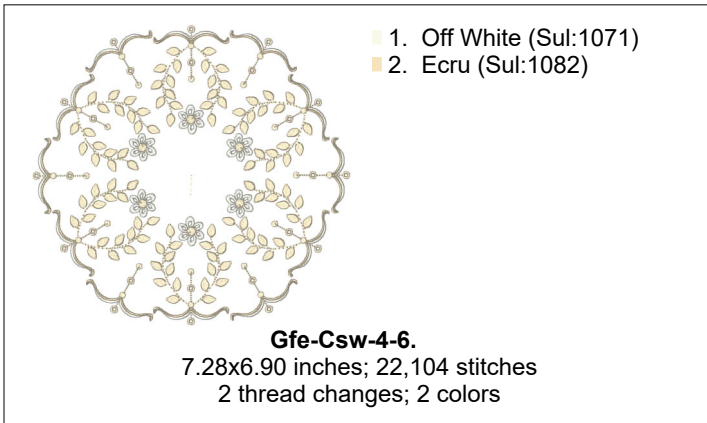



- 1. Off White (Sul:1071)
- 2. Ecrú (Sul:1082)
- 3. Off White (Sul:1071)
- 4. Ecrú (Sul:1082)

Gfe-Csw-5-1.

5.46x13.32 inches; 49,168 stitches
4 thread changes; 2 colors



- 1. Ecrú (Sul:1082)
- 2. Off White (Sul:1071)
- 3. Ecrú (Sul:1082)
- 4. Off White (Sul:1071)
- 5. Ecrú (Sul:1082)
- 6. Off White (Sul:1071)

Gfe-Csw-5-10.

7.24x13.46 inches; 48,237 stitches
6 thread changes; 2 colors



- 1. Ecrú (Sul:1082)
- 2. Off White (Sul:1071)
- 3. Ecrú (Sul:1082)
- 4. Off White (Sul:1071)
- 5. Ecrú (Sul:1082)
- 6. Off White (Sul:1071)
- 7. Ecrú (Sul:1082)

Gfe-Csw-5-2.

7.49x14.00 inches; 46,884 stitches
7 thread changes; 2 colors



- 1. Ecrú (Sul:1082)
- 2. Off White (Sul:1071)
- 3. Ecrú (Sul:1082)
- 4. Off White (Sul:1071)

Gfe-Csw-5-3.

7.35x13.40 inches; 30,413 stitches
4 thread changes; 2 colors



- 1. Ecrú (Sul:1082)
- 2. Off White (Sul:1071)
- 3. Ecrú (Sul:1082)
- 4. Off White (Sul:1071)

Gfe-Csw-5-3lt.

7.45x13.40 inches; 35,269 stitches
4 thread changes; 2 colors



- 1. Ecrú (Sul:1082)
- 2. Off White (Sul:1071)
- 3. Ecrú (Sul:1082)
- 4. Off White (Sul:1071)

Gfe-Csw-5-3rt.

7.47x13.42 inches; 39,729 stitches
4 thread changes; 2 colors



- 1. Ecrú (Sul:1082)
- 2. Off White (Sul:1071)
- 3. Ecrú (Sul:1082)
- 4. Off White (Sul:1071)

Gfe-Csw-5-4.

7.63x14.02 inches; 36,857 stitches
4 thread changes; 2 colors



- 1. Off White (Sul:1071)
- 2. Ecrú (Sul:1082)
- 3. Off White (Sul:1071)
- 4. Ecrú (Sul:1082)
- 5. Off White (Sul:1071)

Gfe-Csw-5-5.

7.25x13.63 inches; 68,584 stitches
5 thread changes; 2 colors

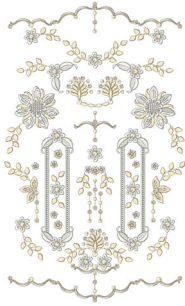

- 1. Ecrú (Sul:1082)
- 2. Off White (Sul:1071)
- 3. Ecrú (Sul:1082)
- 4. Off White (Sul:1071)
- 5. Ecrú (Sul:1082)
- 6. Off White (Sul:1071)

Gfe-Csw-5-6.

7.55x12.57 inches; 60,323 stitches
6 thread changes; 2 colors



- 1. Off White (Sul:1071)
- 2. Ecrú (Sul:1082)
- 3. Off White (Sul:1071)
- 4. Ecrú (Sul:1082)
- 5. Off White (Sul:1071)

Gfe-Csw-5-7.

6.20x13.37 inches; 114,583 stitches
5 thread changes; 2 colors

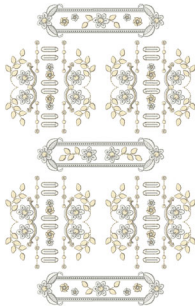

- 1. Off White (Sul:1071)
- 2. Ecrú (Sul:1082)
- 3. Off White (Sul:1071)
- 4. Ecrú (Sul:1082)
- 5. Off White (Sul:1071)

Gfe-Csw-5-8.

7.70x12.20 inches; 70,359 stitches
5 thread changes; 2 colors



- 1. Off White (Sul:1071)
- 2. Ecrú (Sul:1082)
- 3. Off White (Sul:1071)
- 4. Ecrú (Sul:1082)

Gfe-Csw-5-9.

6.19x12.31 inches; 48,886 stitches
4 thread changes; 2 colors