



Symphony of Flowers 1

Scroll down to view all the sets in this collection



- 1. Med. Weathered Blue (Sul-R:1172)
- 2. Burnt Toast (Sul-R:1265)
- 3. Lt. Putty (Sul-R:1229)
- 4. Putty (Sul-R:1508)
- 5. Off White (Sul-R:1071)
- 6. Silver Gray (Sul-R:1218)
- 7. Dk. Ecru (Sul-R:1128)

Gfe_sof1_10.vp3
3.90x2.42 inches; 8,125 stitches
7 thread changes; 7 colors



- 1. Med. Weathered Blue (Sul-R:1172)
- 2. Med. Weathered Blue (Sul-R:1172)
- 3. Burnt Toast (Sul-R:1265)
- 4. Dk. Gray Khaki (Sul-R:1270)
- 5. Drab Green (Sul-R:1228)
- 6. Cream (Sul-R:1022)
- 7. Gold (Sul-R:1070)
- 8. Sunflower Gold (Sul-R:1333)
- 9. Off White (Sul-R:1071)
- 10. Silver Gray (Sul-R:1218)
- 11. Dk. Ecru (Sul-R:1128)

Gfe_sof1_11.vp3
3.71x3.38 inches; 10,853 stitches
11 thread changes; 10 colors



- 1. Med. Weathered Blue (Sul-R:1172)
- 2. Burnt Toast (Sul-R:1265)
- 3. Khaki (Sul-R:1212)
- 4. Dewberry (Sul-R:1304)
- 5. Lt. Putty (Sul-R:1229)
- 6. Putty (Sul-R:1508)
- 7. Off White (Sul-R:1071)
- 8. Silver Gray (Sul-R:1218)
- 9. Dk. Ecru (Sul-R:1128)

Gfe_sof1_12.vp3
3.50x3.15 inches; 7,616 stitches
9 thread changes; 9 colors



- 1. Burnt Toast (Sul-R:1265)
- 2. Dk. Gray Khaki (Sul-R:1270)
- 3. Dewberry (Sul-R:1304)
- 4. Silver (Sul-R:1085)
- 5. Med. Chestnut (Sul-R:1214)
- 6. Taupe (Sul-R:1213)
- 7. Dewberry (Sul-R:1304)
- 8. Moss Green (Sul-R:630)
- 9. Putty (Sul-R:1508)

Gfe_sof1_13.vp3
3.58x3.75 inches; 7,926 stitches
9 thread changes; 8 colors



- 1. Med. Weathered Blue (Sul-R:1172)
- 2. Burnt Toast (Sul-R:1265)
- 3. Khaki (Sul-R:1212)
- 4. Dewberry (Sul-R:1304)
- 5. Dk. Gray Khaki (Sul-R:1270)
- 6. Lt. Putty (Sul-R:1229)
- 7. Putty (Sul-R:1508)
- 8. Off White (Sul-R:1071)
- 9. Silver Gray (Sul-R:1218)
- 10. Dk. Ecru (Sul-R:1128)

Gfe_sof1_14.vp3
3.89x3.19 inches; 7,390 stitches
10 thread changes; 10 colors



- 1. Med. Weathered Blue (Sul-R:1172)
- 2. Burnt Toast (Sul-R:1265)
- 3. Khaki (Sul-R:1212)
- 4. Dewberry (Sul-R:1304)
- 5. Dk. Gray Khaki (Sul-R:1270)
- 6. Drab Green (Sul-R:1228)
- 7. Cream (Sul-R:1022)
- 8. Gold (Sul-R:1070)
- 9. Sunflower Gold (Sul-R:1333)

Gfe_sof1_15.vp3
3.70x3.88 inches; 8,111 stitches
9 thread changes; 9 colors



- 1. Med. Weathered Blue (Sul-R:1172)
- 2. Burnt Toast (Sul-R:1265)
- 3. Khaki (Sul-R:1212)
- 4. Dewberry (Sul-R:1304)
- 5. Lt. Putty (Sul-R:1229)
- 6. Putty (Sul-R:1508)
- 7. Off White (Sul-R:1071)
- 8. Silver Gray (Sul-R:1218)
- 9. Dk. Ecru (Sul-R:1128)

Gfe_sof1_16.vp3
3.88x3.34 inches; 7,855 stitches
9 thread changes; 9 colors

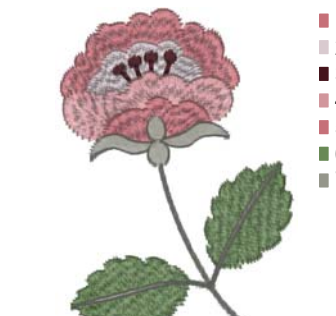

- 1. Dewberry (Sul-R:1304)
- 2. Silver (Sul-R:1085)
- 3. Med. Chestnut (Sul-R:1214)
- 4. Taupe (Sul-R:1213)
- 5. Dewberry (Sul-R:1304)
- 6. Moss Green (Sul-R:630)
- 7. Putty (Sul-R:1508)

Gfe_sof1_17.vp3
1.62x2.34 inches; 4,120 stitches
7 thread changes; 6 colors

Symphony of Flowers 1

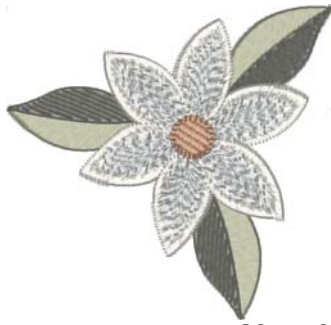

- 1. Lt. Putty (Sul-R:1229)
- 2. Putty (Sul-R:1508)
- 3. Off White (Sul-R:1071)
- 4. Silver Gray (Sul-R:1218)
- 5. Dk. Ecru (Sul-R:1128)

Gfe_sof1_17.vp3

2.35x2.27 inches; 6,679 stitches
5 thread changes; 5 colors



- 1. Drab Green (Sul-R:1228)
- 2. Cream (Sul-R:1022)
- 3. Gold (Sul-R:1070)
- 4. Sunflower Gold (Sul-R:1333)

Gfe_sof1_18.vp3

1.73x1.89 inches; 4,892 stitches
4 thread changes; 4 colors

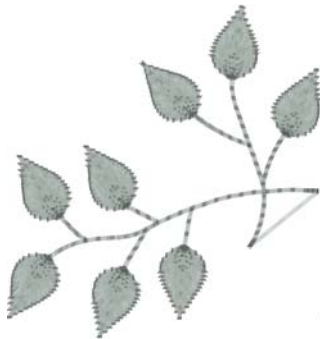

- 1. Dk. Gray Khaki (Sul-R:1270)

Gfe_sof1_19.vp3

2.24x2.41 inches; 1,169 stitches
1 thread changes; 1 colors



- 1. Med. Weathered Blue (Sul-R:1172)
- 2. Burnt Toast (Sul-R:1265)
- 3. Khaki (Sul-R:1212)
- 4. Dewberry (Sul-R:1304)
- 5. Drab Green (Sul-R:1228)
- 6. Cream (Sul-R:1022)
- 7. Gold (Sul-R:1070)
- 8. Sunflower Gold (Sul-R:1333)

Gfe_sof1_2.vp3

3.66x3.20 inches; 6,711 stitches
8 thread changes; 8 colors



- 1. Burnt Toast (Sul-R:1265)

Gfe_sof1_20.vp3

2.95x3.22 inches; 1,298 stitches
1 thread changes; 1 colors



- 1. Lt. Khaki (Sul-R:1211)
- 2. Drab Green (Sul-R:1228)
- 3. Cream (Sul-R:1022)
- 4. Gold (Sul-R:1070)
- 5. Sunflower Gold (Sul-R:1333)

Gfe_sof1_21.vp3

2.45x2.83 inches; 5,135 stitches
5 thread changes; 5 colors



- 1. Med. Weathered Blue (Sul-R:1172)
- 2. Khaki (Sul-R:1212)
- 3. Dewberry (Sul-R:1304)
- 4. Off White (Sul-R:1071)
- 5. Silver Gray (Sul-R:1218)
- 6. Dk. Ecru (Sul-R:1128)

Gfe_sof1_22.vp3

3.89x2.14 inches; 5,877 stitches
6 thread changes; 6 colors



- 1. Dewberry (Sul-R:1304)
- 2. Silver (Sul-R:1085)
- 3. Med. Chestnut (Sul-R:1214)
- 4. Taupe (Sul-R:1213)
- 5. Dewberry (Sul-R:1304)
- 6. Moss Green (Sul-R:630)
- 7. Putty (Sul-R:1508)

Gfe_sof1_23.vp3

3.07x1.71 inches; 4,187 stitches
7 thread changes; 6 colors

Symphony of Flowers 1



- 1. Med. Weathered Blue (Sul-R:1172)
- 2. Moss Green (Sul-R:630)
- 3. Khaki (Sul-R:1212)
- 4. Dk. Gray Khaki (Sul-R:1270)
- 5. Dewberry (Sul-R:1304)
- 6. Silver (Sul-R:1085)
- 7. Med. Chestnut (Sul-R:1214)
- 8. Taupe (Sul-R:1213)
- 9. Dewberry (Sul-R:1304)
- 10. Putty (Sul-R:1508)
- 11. Off White (Sul-R:1071)
- 12. Silver Gray (Sul-R:1218)
- 13. Dk. Ecreu (Sul-R:1128)

Gfe_sof1_24.vp3
3.83x2.82 inches; 9,328 stitches
13 thread changes; 12 colors



- 1. Lt. Khaki (Sul-R:1211)
- 2. Drab Green (Sul-R:1228)
- 3. Cream (Sul-R:1022)
- 4. Gold (Sul-R:1070)
- 5. Sunflower Gold (Sul-R:1333)
- 6. Dewberry (Sul-R:1304)
- 7. Silver (Sul-R:1085)
- 8. Med. Chestnut (Sul-R:1214)
- 9. Taupe (Sul-R:1213)
- 10. Dewberry (Sul-R:1304)
- 11. Moss Green (Sul-R:630)
- 12. Putty (Sul-R:1508)

Gfe_sof1_25.vp3
3.45x2.94 inches; 9,410 stitches
12 thread changes; 11 colors



- 1. Med. Weathered Blue (Sul-R:1172)
- 2. Lt. Putty (Sul-R:1229)
- 3. Putty (Sul-R:1508)
- 4. Off White (Sul-R:1071)
- 5. Silver Gray (Sul-R:1218)
- 6. Dk. Ecreu (Sul-R:1128)

Gfe_sof1_26.vp3
3.86x2.71 inches; 13,092 stitches
6 thread changes; 6 colors



- 1. Med. Weathered Blue (Sul-R:1172)

Gfe_sof1_27.vp3
1.76x0.93 inches; 557 stitches
1 thread changes; 1 colors



- 1. Med. Weathered Blue (Sul-R:1172)
- 2. Med. Weathered Blue (Sul-R:1172)

Gfe_sof1_28.vp3
1.76x1.05 inches; 537 stitches
2 thread changes; 1 colors



- 1. Med. Weathered Blue (Sul-R:1172)

Gfe_sof1_29.vp3
1.68x0.94 inches; 396 stitches
1 thread changes; 1 colors



- 1. Med. Weathered Blue (Sul-R:1172)
- 2. Burnt Toast (Sul-R:1265)
- 3. Dewberry (Sul-R:1304)
- 4. Silver (Sul-R:1085)
- 5. Med. Chestnut (Sul-R:1214)
- 6. Taupe (Sul-R:1213)
- 7. Dewberry (Sul-R:1304)
- 8. Moss Green (Sul-R:630)
- 9. Putty (Sul-R:1508)

Gfe_sof1_3.vp3
3.51x3.41 inches; 5,771 stitches
9 thread changes; 8 colors



- 1. Med. Weathered Blue (Sul-R:1172)

Gfe_sof1_30.vp3
1.69x0.74 inches; 381 stitches
1 thread changes; 1 colors

Symphony of Flowers 1



- 1. Med. Weathered Blue (Sul-R:1172)
- 2. Med. Weathered Blue (Sul-R:1172)
- 3. Burnt Toast (Sul-R:1265)
- 4. Khaki (Sul-R:1212)
- 5. Dewberry (Sul-R:1304)
- 6. Dk. Gray Khaki (Sul-R:1270)
- 7. Lt. Putty (Sul-R:1229)
- 8. Putty (Sul-R:1508)
- 9. Off White (Sul-R:1071)
- 10. Silver Gray (Sul-R:1218)
- 11. Dk. Ecru (Sul-R:1128)

Gfe_sof1_4_vp3
3.57x3.54 inches; 8,245 stitches
11 thread changes; 10 colors



- 1. Med. Weathered Blue (Sul-R:1172)
- 2. Med. Weathered Blue (Sul-R:1172)
- 3. Burnt Toast (Sul-R:1265)
- 4. Khaki (Sul-R:1212)
- 5. Dewberry (Sul-R:1304)
- 6. Dk. Gray Khaki (Sul-R:1270)
- 7. Drab Green (Sul-R:1228)
- 8. Cream (Sul-R:1022)
- 9. Gold (Sul-R:1070)
- 10. Sunflower Gold (Sul-R:1333)

Gfe_sof1_5_vp3
3.91x2.92 inches; 7,232 stitches
10 thread changes; 9 colors



- 1. Med. Weathered Blue (Sul-R:1172)
- 2. Burnt Toast (Sul-R:1265)
- 3. Dk. Gray Khaki (Sul-R:1270)
- 4. Cream (Sul-R:1022)
- 5. Gold (Sul-R:1070)
- 6. Sunflower Gold (Sul-R:1333)

Gfe_sof1_6_vp3
3.87x2.96 inches; 5,877 stitches
6 thread changes; 6 colors



- 1. Med. Weathered Blue (Sul-R:1172)
- 2. Burnt Toast (Sul-R:1265)
- 3. Khaki (Sul-R:1212)
- 4. Dewberry (Sul-R:1304)
- 5. Dk. Gray Khaki (Sul-R:1270)
- 6. Lt. Putty (Sul-R:1229)
- 7. Putty (Sul-R:1508)
- 8. Off White (Sul-R:1071)
- 9. Silver Gray (Sul-R:1218)
- 10. Dk. Ecru (Sul-R:1128)

Gfe_sof1_7_vp3
3.69x3.91 inches; 8,156 stitches
10 thread changes; 10 colors



- 1. Burnt Toast (Sul-R:1265)
- 2. Khaki (Sul-R:1212)
- 3. Dewberry (Sul-R:1304)
- 4. Dk. Gray Khaki (Sul-R:1270)
- 5. Drab Green (Sul-R:1228)
- 6. Cream (Sul-R:1022)
- 7. Gold (Sul-R:1070)
- 8. Sunflower Gold (Sul-R:1333)

Gfe_sof1_8_vp3
3.13x3.43 inches; 6,674 stitches
8 thread changes; 8 colors



- 1. Burnt Toast (Sul-R:1265)
- 2. Khaki (Sul-R:1212)
- 3. Dewberry (Sul-R:1304)
- 4. Dk. Gray Khaki (Sul-R:1270)
- 5. Moss Green (Sul-R:630)
- 6. Dewberry (Sul-R:1304)
- 7. Silver (Sul-R:1085)
- 8. Med. Chestnut (Sul-R:1214)
- 9. Taupe (Sul-R:1213)
- 10. Dewberry (Sul-R:1304)
- 11. Putty (Sul-R:1508)
- 12. Drab Green (Sul-R:1228)
- 13. Cream (Sul-R:1022)
- 14. Gold (Sul-R:1070)
- 15. Sunflower Gold (Sul-R:1333)

Gfe_sof1_9_vp3
3.82x3.88 inches; 11,222 stitches
15 thread changes; 13 colors

Symphony of Flowers 2



■ 1. Med. Weathered Blue (Sul-R:1172)

Gfe_sof1_27.vp3
1.76x0.93 inches; 557 stitches
1 thread changes; 1 colors



■ 1. Med. Weathered Blue (Sul-R:1172)
■ 2. Med. Weathered Blue (Sul-R:1172)

Gfe_sof1_28.vp3
1.76x1.05 inches; 537 stitches
2 thread changes; 1 colors



■ 1. Med. Weathered Blue (Sul-R:1172)

Gfe_sof1_29.vp3
1.68x0.94 inches; 396 stitches
1 thread changes; 1 colors



■ 1. Med. Weathered Blue (Sul-R:1172)

Gfe_sof1_30.vp3
1.69x0.74 inches; 381 stitches
1 thread changes; 1 colors



■ 1. Burnt Toast (Sul-R:1265)
■ 2. Khaki (Sul-R:1212)
■ 3. Dk. Gray Khaki (Sul-R:1270)
■ 4. Drab Green (Sul-R:1228)
■ 5. Cream (Sul-R:1022)
■ 6. Gold (Sul-R:1070)
■ 7. Sunflower Gold (Sul-R:1333)
■ 8. Dewberry (Sul-R:1304)
■ 9. Silver (Sul-R:1085)
■ 10. Med. Chestnut (Sul-R:1214)
■ 11. Taupe (Sul-R:1213)
■ 12. Dewberry (Sul-R:1304)
■ 13. Putty (Sul-R:1508)
■ 14. Lt. Putty (Sul-R:1229)
■ 15. Putty (Sul-R:1508)
■ 16. Off White (Sul-R:1071)
■ 17. Silver Gray (Sul-R:1218)
■ 18. Dk. Ecru (Sul-R:1128)

Gfe_sof2_1.vp3
4.08x5.52 inches; 18,084 stitches
18 thread changes; 16 colors



■ 1. Burnt Toast (Sul-R:1265)
■ 2. Khaki (Sul-R:1212)
■ 3. Dk. Gray Khaki (Sul-R:1270)
■ 4. Dewberry (Sul-R:1304)
■ 5. Silver (Sul-R:1085)
■ 6. Med. Chestnut (Sul-R:1214)
■ 7. Taupe (Sul-R:1213)
■ 8. Dewberry (Sul-R:1304)
■ 9. Moss Green (Sul-R:630)
■ 10. Putty (Sul-R:1508)
■ 11. Drab Green (Sul-R:1228)
■ 12. Cream (Sul-R:1022)
■ 13. Gold (Sul-R:1070)
■ 14. Sunflower Gold (Sul-R:1333)

Gfe_sof2_10.vp3
3.14x6.91 inches; 11,060 stitches
14 thread changes; 13 colors



■ 1. Med. Weathered Blue (Sul-R:1172)
■ 2. Khaki (Sul-R:1212)
■ 3. Dk. Gray Khaki (Sul-R:1270)
■ 4. Dewberry (Sul-R:1304)
■ 5. Silver (Sul-R:1085)
■ 6. Med. Chestnut (Sul-R:1214)
■ 7. Taupe (Sul-R:1213)
■ 8. Dewberry (Sul-R:1304)
■ 9. Moss Green (Sul-R:630)
■ 10. Putty (Sul-R:1508)
■ 11. Lt. Putty (Sul-R:1229)
■ 12. Putty (Sul-R:1508)
■ 13. Off White (Sul-R:1071)
■ 14. Silver Gray (Sul-R:1218)
■ 15. Dk. Ecru (Sul-R:1128)

Gfe_sof2_11.vp3
4.56x6.48 inches; 17,234 stitches
15 thread changes; 13 colors



■ 1. Dk. Gray Khaki (Sul-R:1270)
■ 2. Dewberry (Sul-R:1304)
■ 3. Silver (Sul-R:1085)
■ 4. Med. Chestnut (Sul-R:1214)
■ 5. Taupe (Sul-R:1213)
■ 6. Dewberry (Sul-R:1304)
■ 7. Moss Green (Sul-R:630)
■ 8. Putty (Sul-R:1508)
■ 9. Drab Green (Sul-R:1228)
■ 10. Cream (Sul-R:1022)
■ 11. Gold (Sul-R:1070)
■ 12. Sunflower Gold (Sul-R:1333)
■ 13. Lt. Putty (Sul-R:1229)
■ 14. Putty (Sul-R:1508)
■ 15. Off White (Sul-R:1071)
■ 16. Silver Gray (Sul-R:1218)
■ 17. Dk. Ecru (Sul-R:1128)

Gfe_sof2_12.vp3
4.83x6.48 inches; 20,083 stitches
17 thread changes; 15 colors

Symphony of Flowers 2



- 1. Burnt Toast (Sul-R:1265)
- 2. Khaki (Sul-R:1212)
- 3. Dk. Gray Khaki (Sul-R:1270)
- 4. Dewberry (Sul-R:1304)
- 5. Silver (Sul-R:1085)
- 6. Med. Chestnut (Sul-R:1214)
- 7. Taupe (Sul-R:1213)
- 8. Dewberry (Sul-R:1304)
- 9. Moss Green (Sul-R:630)
- 10. Putty (Sul-R:1508)
- 11. Drab Green (Sul-R:1228)
- 12. Cream (Sul-R:1022)
- 13. Gold (Sul-R:1070)
- 14. Sunflower Gold (Sul-R:1333)
- 15. Lt. Putty (Sul-R:1229)
- 16. Putty (Sul-R:1508)
- 17. Off White (Sul-R:1071)
- 18. Silver Gray (Sul-R:1218)
- 19. Dk. Ecru (Sul-R:1128)

Gfe_sof2_13.vp3

4.25x6.80 inches; 17,169 stitches
19 thread changes; 17 colors



- 1. Burnt Toast (Sul-R:1265)
- 2. Dk. Gray Khaki (Sul-R:1270)
- 3. Drab Green (Sul-R:1228)
- 4. Cream (Sul-R:1022)
- 5. Gold (Sul-R:1070)
- 6. Sunflower Gold (Sul-R:1333)
- 7. Dewberry (Sul-R:1304)
- 8. Silver (Sul-R:1085)
- 9. Med. Chestnut (Sul-R:1214)
- 10. Taupe (Sul-R:1213)
- 11. Dewberry (Sul-R:1304)
- 12. Moss Green (Sul-R:630)
- 13. Putty (Sul-R:1508)
- 14. Lt. Putty (Sul-R:1229)
- 15. Putty (Sul-R:1508)
- 16. Off White (Sul-R:1071)
- 17. Silver Gray (Sul-R:1218)
- 18. Dk. Ecru (Sul-R:1128)

Gfe_sof2_14.vp3

4.10x6.95 inches; 16,817 stitches
18 thread changes; 16 colors



- 1. Med. Weathered Blue (Sul-R:1172)
- 2. Burnt Toast (Sul-R:1265)
- 3. Khaki (Sul-R:1212)
- 4. Dk. Gray Khaki (Sul-R:1270)
- 5. Dewberry (Sul-R:1304)
- 6. Silver (Sul-R:1085)
- 7. Med. Chestnut (Sul-R:1214)
- 8. Taupe (Sul-R:1213)
- 9. Dewberry (Sul-R:1304)
- 10. Moss Green (Sul-R:630)
- 11. Cream (Sul-R:1022)
- 12. Gold (Sul-R:1070)
- 13. Sunflower Gold (Sul-R:1333)
- 14. Lt. Putty (Sul-R:1229)
- 15. Putty (Sul-R:1508)
- 16. Off White (Sul-R:1071)
- 17. Silver Gray (Sul-R:1218)
- 18. Dk. Ecru (Sul-R:1128)

Gfe_sof2_15.vp3

5.02x6.61 inches; 15,990 stitches
18 thread changes; 17 colors



- 1. Med. Weathered Blue (Sul-R:1172)
- 2. Med. Weathered Blue (Sul-R:1172)
- 3. Khaki (Sul-R:1212)
- 4. Dk. Gray Khaki (Sul-R:1270)
- 5. Moss Green (Sul-R:630)
- 6. Putty (Sul-R:1508)
- 7. Silver (Sul-R:1085)
- 8. Dewberry (Sul-R:1304)
- 9. Silver (Sul-R:1085)
- 10. Med. Chestnut (Sul-R:1214)
- 11. Taupe (Sul-R:1213)
- 12. Dewberry (Sul-R:1304)
- 13. Putty (Sul-R:1508)
- 14. Cream (Sul-R:1022)
- 15. Gold (Sul-R:1070)
- 16. Sunflower Gold (Sul-R:1333)
- 17. Lt. Putty (Sul-R:1229)
- 18. Putty (Sul-R:1508)
- 19. Off White (Sul-R:1071)
- 20. Silver Gray (Sul-R:1218)
- 21. Dk. Ecru (Sul-R:1128)

Gfe_sof2_2.vp3

3.06x6.96 inches; 15,475 stitches
21 thread changes; 16 colors



- 1. Med. Weathered Blue (Sul-R:1172)
- 2. Med. Weathered Blue (Sul-R:1172)
- 3. Burnt Toast (Sul-R:1265)
- 4. Khaki (Sul-R:1212)
- 5. Dk. Gray Khaki (Sul-R:1270)
- 6. Moss Green (Sul-R:630)
- 7. Putty (Sul-R:1508)
- 8. Dewberry (Sul-R:1304)
- 9. Silver (Sul-R:1085)
- 10. Med. Chestnut (Sul-R:1214)
- 11. Taupe (Sul-R:1213)
- 12. Dewberry (Sul-R:1304)
- 13. Putty (Sul-R:1508)
- 14. Cream (Sul-R:1022)
- 15. Gold (Sul-R:1070)
- 16. Sunflower Gold (Sul-R:1333)
- 17. Lt. Putty (Sul-R:1229)
- 18. Putty (Sul-R:1508)
- 19. Off White (Sul-R:1071)
- 20. Silver Gray (Sul-R:1218)
- 21. Dk. Ecru (Sul-R:1128)

Gfe_sof2_3.vp3

4.83x6.02 inches; 16,380 stitches
21 thread changes; 17 colors



- 1. Burnt Toast (Sul-R:1265)
- 2. Khaki (Sul-R:1212)
- 3. Dk. Gray Khaki (Sul-R:1270)
- 4. Dewberry (Sul-R:1304)
- 5. Silver (Sul-R:1085)
- 6. Med. Chestnut (Sul-R:1214)
- 7. Taupe (Sul-R:1213)
- 8. Dewberry (Sul-R:1304)
- 9. Moss Green (Sul-R:630)
- 10. Lt. Putty (Sul-R:1229)
- 11. Putty (Sul-R:1508)
- 12. Drab Green (Sul-R:1228)
- 13. Cream (Sul-R:1022)
- 14. Gold (Sul-R:1070)
- 15. Sunflower Gold (Sul-R:1333)
- 16. Off White (Sul-R:1071)
- 17. Silver Gray (Sul-R:1218)
- 18. Dk. Ecru (Sul-R:1128)

Gfe_sof2_4.vp3

4.09x6.92 inches; 18,000 stitches
18 thread changes; 17 colors



- 1. Med. Weathered Blue (Sul-R:1172)
- 2. Burnt Toast (Sul-R:1265)
- 3. Khaki (Sul-R:1212)
- 4. Dk. Gray Khaki (Sul-R:1270)
- 5. Cream (Sul-R:1022)
- 6. Gold (Sul-R:1070)
- 7. Sunflower Gold (Sul-R:1333)
- 8. Drab Green (Sul-R:1228)
- 9. Dewberry (Sul-R:1304)
- 10. Silver (Sul-R:1085)
- 11. Med. Chestnut (Sul-R:1214)
- 12. Taupe (Sul-R:1213)
- 13. Dewberry (Sul-R:1304)
- 14. Lt. Putty (Sul-R:1229)
- 15. Putty (Sul-R:1508)
- 16. Off White (Sul-R:1071)
- 17. Silver Gray (Sul-R:1218)
- 18. Dk. Ecru (Sul-R:1128)

Gfe_sof2_5.vp3

4.67x5.09 inches; 16,097 stitches
18 thread changes; 17 colors



- 1. Burnt Toast (Sul-R:1265)
- 2. Dk. Gray Khaki (Sul-R:1270)
- 3. Drab Green (Sul-R:1228)
- 4. Khaki (Sul-R:1212)
- 5. Dewberry (Sul-R:1304)
- 6. Silver (Sul-R:1085)
- 7. Med. Chestnut (Sul-R:1214)
- 8. Taupe (Sul-R:1213)
- 9. Dewberry (Sul-R:1304)
- 10. Moss Green (Sul-R:630)
- 11. Putty (Sul-R:1508)
- 12. Cream (Sul-R:1022)
- 13. Gold (Sul-R:1070)
- 14. Sunflower Gold (Sul-R:1333)
- 15. Lt. Putty (Sul-R:1229)
- 16. Putty (Sul-R:1508)
- 17. Off White (Sul-R:1071)
- 18. Silver Gray (Sul-R:1218)
- 19. Dk. Ecru (Sul-R:1128)

Gfe_sof2_6.vp3

3.99x5.26 inches; 16,363 stitches
19 thread changes; 17 colors

Symphony of Flowers 2

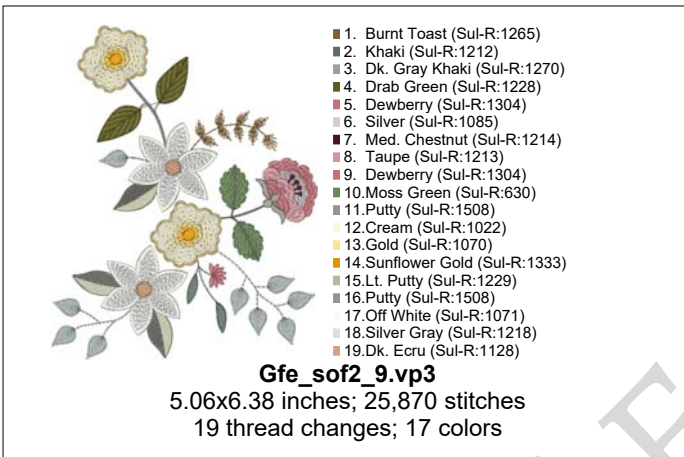
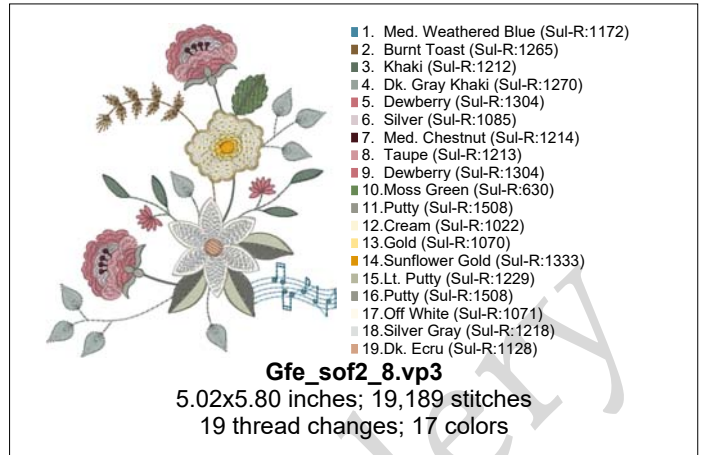
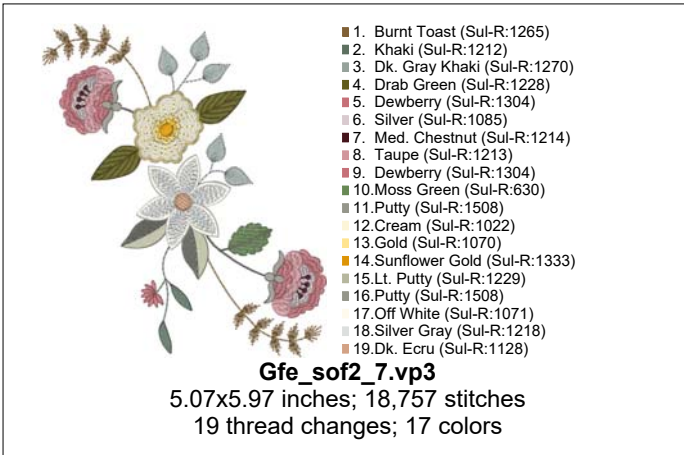

Symphony of Flowers 3



■ 1. Med. Weathered Blue (Sul-R:1172)

Gfe_sof1_27.vp3
1.76x0.93 inches; 557 stitches
1 thread changes; 1 colors



■ 1. Med. Weathered Blue (Sul-R:1172)
■ 2. Med. Weathered Blue (Sul-R:1172)

Gfe_sof1_28.vp3
1.76x1.05 inches; 537 stitches
2 thread changes; 1 colors



■ 1. Med. Weathered Blue (Sul-R:1172)

Gfe_sof1_29.vp3
1.68x0.94 inches; 396 stitches
1 thread changes; 1 colors



■ 1. Med. Weathered Blue (Sul-R:1172)

Gfe_sof1_30.vp3
1.69x0.74 inches; 381 stitches
1 thread changes; 1 colors



- 1. Dk. Gray Khaki (Sul-R:1270)
- 2. Khaki (Sul-R:1212)
- 3. Moss Green (Sul-R:630)
- 4. Dewberry (Sul-R:1304)
- 5. Putty (Sul-R:1508)
- 6. Silver (Sul-R:1085)
- 7. Med. Chestnut (Sul-R:1214)
- 8. Taupe (Sul-R:1213)
- 9. Dewberry (Sul-R:1304)
- 10. Putty (Sul-R:1508)
- 11. Cream (Sul-R:1022)
- 12. Gold (Sul-R:1070)
- 13. Sunflower Gold (Sul-R:1333)
- 14. Lt. Putty (Sul-R:1229)
- 15. Putty (Sul-R:1508)
- 16. Off White (Sul-R:1071)
- 17. Silver Gray (Sul-R:1218)
- 18. Dk. Ecru (Sul-R:1128)

Gfe_sof3_1.vp3
5.87x6.20 inches; 28,559 stitches
18 thread changes; 15 colors

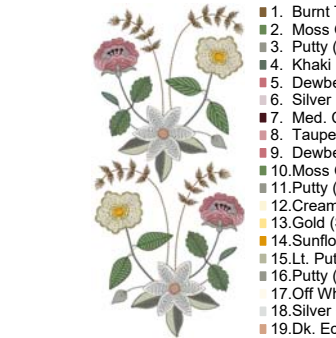

- 1. Burnt Toast (Sul-R:1265)
- 2. Moss Green (Sul-R:630)
- 3. Putty (Sul-R:1508)
- 4. Khaki (Sul-R:1212)
- 5. Dewberry (Sul-R:1304)
- 6. Silver (Sul-R:1085)
- 7. Med. Chestnut (Sul-R:1214)
- 8. Taupe (Sul-R:1213)
- 9. Dewberry (Sul-R:1304)
- 10. Moss Green (Sul-R:630)
- 11. Putty (Sul-R:1508)
- 12. Cream (Sul-R:1022)
- 13. Gold (Sul-R:1070)
- 14. Sunflower Gold (Sul-R:1333)
- 15. Lt. Putty (Sul-R:1229)
- 16. Putty (Sul-R:1508)
- 17. Off White (Sul-R:1071)
- 18. Silver Gray (Sul-R:1218)
- 19. Dk. Ecru (Sul-R:1128)

Gfe_sof3_10.vp3
4.17x9.33 inches; 33,398 stitches
19 thread changes; 15 colors

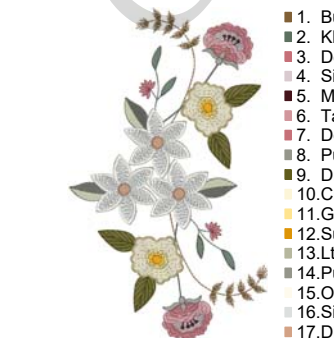

- 1. Burnt Toast (Sul-R:1265)
- 2. Khaki (Sul-R:1212)
- 3. Dewberry (Sul-R:1304)
- 4. Silver (Sul-R:1085)
- 5. Med. Chestnut (Sul-R:1214)
- 6. Taupe (Sul-R:1213)
- 7. Dewberry (Sul-R:1304)
- 8. Putty (Sul-R:1508)
- 9. Drab Green (Sul-R:1228)
- 10. Cream (Sul-R:1022)
- 11. Gold (Sul-R:1070)
- 12. Sunflower Gold (Sul-R:1333)
- 13. Lt. Putty (Sul-R:1229)
- 14. Putty (Sul-R:1508)
- 15. Off White (Sul-R:1071)
- 16. Silver Gray (Sul-R:1218)
- 17. Dk. Ecru (Sul-R:1128)

Gfe_sof3_2.vp3
4.87x8.24 inches; 32,014 stitches
17 thread changes; 15 colors

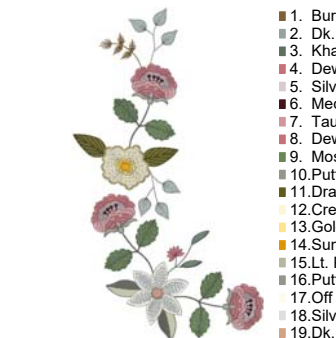

- 1. Burnt Toast (Sul-R:1265)
- 2. Dk. Gray Khaki (Sul-R:1270)
- 3. Khaki (Sul-R:1212)
- 4. Dewberry (Sul-R:1304)
- 5. Silver (Sul-R:1085)
- 6. Med. Chestnut (Sul-R:1214)
- 7. Taupe (Sul-R:1213)
- 8. Dewberry (Sul-R:1304)
- 9. Moss Green (Sul-R:630)
- 10. Putty (Sul-R:1508)
- 11. Drab Green (Sul-R:1228)
- 12. Cream (Sul-R:1022)
- 13. Gold (Sul-R:1070)
- 14. Sunflower Gold (Sul-R:1333)
- 15. Lt. Putty (Sul-R:1229)
- 16. Putty (Sul-R:1508)
- 17. Off White (Sul-R:1071)
- 18. Silver Gray (Sul-R:1218)
- 19. Dk. Ecru (Sul-R:1128)

Gfe_sof3_3.vp3
5.11x9.03 inches; 24,757 stitches
19 thread changes; 17 colors

Symphony of Flowers 3



- 1. Burnt Toast (Sul-R:1265)
- 2. Khaki (Sul-R:1212)
- 3. Dewberry (Sul-R:1304)
- 4. Silver (Sul-R:1085)
- 5. Med. Chestnut (Sul-R:1214)
- 6. Taupe (Sul-R:1213)
- 7. Dewberry (Sul-R:1304)
- 8. Moss Green (Sul-R:630)
- 9. Putty (Sul-R:1508)
- 10. Cream (Sul-R:1022)
- 11. Gold (Sul-R:1070)
- 12. Sunflower Gold (Sul-R:1333)
- 13. Lt. Putty (Sul-R:1229)
- 14. Putty (Sul-R:1508)
- 15. Off White (Sul-R:1071)
- 16. Silver Gray (Sul-R:1218)
- 17. Dk. Ecru (Sul-R:1128)

Gfe_sof3_4.vp3

4.58x9.40 inches; 24,410 stitches
17 thread changes; 15 colors



- 1. Dk. Gray Khaki (Sul-R:1270)
- 2. Khaki (Sul-R:1212)
- 3. Dewberry (Sul-R:1304)
- 4. Silver (Sul-R:1085)
- 5. Med. Chestnut (Sul-R:1214)
- 6. Taupe (Sul-R:1213)
- 7. Dewberry (Sul-R:1304)
- 8. Moss Green (Sul-R:630)
- 9. Putty (Sul-R:1508)
- 10. Drab Green (Sul-R:1228)
- 11. Cream (Sul-R:1022)
- 12. Gold (Sul-R:1070)
- 13. Sunflower Gold (Sul-R:1333)
- 14. Lt. Putty (Sul-R:1229)
- 15. Putty (Sul-R:1508)
- 16. Off White (Sul-R:1071)
- 17. Silver Gray (Sul-R:1218)
- 18. Dk. Ecru (Sul-R:1128)

Gfe_sof3_5.vp3

4.83x8.07 inches; 20,615 stitches
18 thread changes; 16 colors



- 1. Med. Weathered Blue (Sul-R:1172)
- 2. Med. Weathered Blue (Sul-R:1172)
- 3. Burnt Toast (Sul-R:1265)
- 4. Dk. Gray Khaki (Sul-R:1270)
- 5. Khaki (Sul-R:1212)
- 6. Dewberry (Sul-R:1304)
- 7. Silver (Sul-R:1085)
- 8. Med. Chestnut (Sul-R:1214)
- 9. Taupe (Sul-R:1213)
- 10. Dewberry (Sul-R:1304)
- 11. Moss Green (Sul-R:630)
- 12. Putty (Sul-R:1508)
- 13. Lt. Putty (Sul-R:1229)
- 14. Putty (Sul-R:1508)
- 15. Drab Green (Sul-R:1228)
- 16. Cream (Sul-R:1022)
- 17. Gold (Sul-R:1070)
- 18. Sunflower Gold (Sul-R:1333)
- 19. Off White (Sul-R:1071)
- 20. Silver Gray (Sul-R:1218)
- 21. Dk. Ecru (Sul-R:1128)

Gfe_sof3_6.vp3

4.69x8.19 inches; 24,764 stitches
21 thread changes; 18 colors



- 1. Med. Weathered Blue (Sul-R:1172)
- 2. Med. Weathered Blue (Sul-R:1172)
- 3. Burnt Toast (Sul-R:1265)
- 4. Dk. Gray Khaki (Sul-R:1270)
- 5. Khaki (Sul-R:1212)
- 6. Drab Green (Sul-R:1228)
- 7. Moss Green (Sul-R:630)
- 8. Dewberry (Sul-R:1304)
- 9. Silver (Sul-R:1085)
- 10. Med. Chestnut (Sul-R:1214)
- 11. Taupe (Sul-R:1213)
- 12. Dewberry (Sul-R:1304)
- 13. Putty (Sul-R:1508)
- 14. Cream (Sul-R:1022)
- 15. Gold (Sul-R:1070)
- 16. Sunflower Gold (Sul-R:1333)
- 17. Lt. Putty (Sul-R:1229)
- 18. Putty (Sul-R:1508)
- 19. Off White (Sul-R:1071)
- 20. Silver Gray (Sul-R:1218)
- 21. Dk. Ecru (Sul-R:1128)

Gfe_sof3_7.vp3

5.87x8.88 inches; 29,496 stitches
21 thread changes; 18 colors



- 1. Burnt Toast (Sul-R:1265)
- 2. Dk. Gray Khaki (Sul-R:1270)
- 3. Dewberry (Sul-R:1304)
- 4. Silver (Sul-R:1085)
- 5. Med. Chestnut (Sul-R:1214)
- 6. Taupe (Sul-R:1213)
- 7. Dewberry (Sul-R:1304)
- 8. Moss Green (Sul-R:630)
- 9. Putty (Sul-R:1508)
- 10. Lt. Putty (Sul-R:1229)
- 11. Putty (Sul-R:1508)
- 12. Off White (Sul-R:1071)
- 13. Silver Gray (Sul-R:1218)
- 14. Dk. Ecru (Sul-R:1128)

Gfe_sof3_8.vp3

5.53x7.22 inches; 32,697 stitches
14 thread changes; 12 colors



- 1. Med. Weathered Blue (Sul-R:1172)
- 2. Med. Weathered Blue (Sul-R:1172)
- 3. Burnt Toast (Sul-R:1265)
- 4. Dk. Gray Khaki (Sul-R:1270)
- 5. Khaki (Sul-R:1212)
- 6. Moss Green (Sul-R:630)
- 7. Dewberry (Sul-R:1304)
- 8. Silver (Sul-R:1085)
- 9. Med. Chestnut (Sul-R:1214)
- 10. Taupe (Sul-R:1213)
- 11. Dewberry (Sul-R:1304)
- 12. Putty (Sul-R:1508)
- 13. Drab Green (Sul-R:1228)
- 14. Cream (Sul-R:1022)
- 15. Gold (Sul-R:1070)
- 16. Sunflower Gold (Sul-R:1333)
- 17. Off White (Sul-R:1071)
- 18. Silver Gray (Sul-R:1218)
- 19. Dk. Ecru (Sul-R:1128)

Gfe_sof3_9.vp3

5.11x9.12 inches; 24,902 stitches
19 thread changes; 17 colors

Symphony of Flowers 4



■ 1. Med. Weathered Blue (Sul-R:1172)

Gfe_sof1_27.vp3
1.76x0.93 inches; 557 stitches
1 thread changes; 1 colors



■ 1. Med. Weathered Blue (Sul-R:1172)
■ 2. Med. Weathered Blue (Sul-R:1172)

Gfe_sof1_28.vp3
1.76x1.05 inches; 537 stitches
2 thread changes; 1 colors



■ 1. Med. Weathered Blue (Sul-R:1172)

Gfe_sof1_29.vp3
1.68x0.94 inches; 396 stitches
1 thread changes; 1 colors



■ 1. Med. Weathered Blue (Sul-R:1172)

Gfe_sof1_30.vp3
1.69x0.74 inches; 381 stitches
1 thread changes; 1 colors



- 1. Burnt Toast (Sul-R:1265)
- 2. Dk. Gray Khaki (Sul-R:1270)
- 3. Khaki (Sul-R:1212)
- 4. Drab Green (Sul-R:1228)
- 5. Dewberry (Sul-R:1304)
- 6. Silver (Sul-R:1085)
- 7. Med. Chestnut (Sul-R:1214)
- 8. Taupe (Sul-R:1213)
- 9. Dewberry (Sul-R:1304)
- 10. Moss Green (Sul-R:630)
- 11. Lt. Putty (Sul-R:1229)
- 12. Lt. Putty (Sul-R:1229)
- 13. Putty (Sul-R:1508)
- 14. Off White (Sul-R:1071)
- 15. Silver Gray (Sul-R:1218)
- 16. Dk. Ecrú (Sul-R:1128)
- 17. Cream (Sul-R:1022)
- 18. Gold (Sul-R:1070)
- 19. Sunflower Gold (Sul-R:1333)

Gfe_sof4_1.vp3
5.24x11.57 inches; 33,788 stitches
19 thread changes; 17 colors



- 1. Burnt Toast (Sul-R:1265)
- 2. Dk. Gray Khaki (Sul-R:1270)
- 3. Khaki (Sul-R:1212)
- 4. Dewberry (Sul-R:1304)
- 5. Silver (Sul-R:1085)
- 6. Med. Chestnut (Sul-R:1214)
- 7. Taupe (Sul-R:1213)
- 8. Dewberry (Sul-R:1304)
- 9. Moss Green (Sul-R:630)
- 10. Lt. Putty (Sul-R:1229)
- 11. Cream (Sul-R:1022)
- 12. Gold (Sul-R:1070)
- 13. Dk. Ecrú (Sul-R:1128)
- 14. Lt. Putty (Sul-R:1229)
- 15. Putty (Sul-R:1508)
- 16. Off White (Sul-R:1071)
- 17. Silver Gray (Sul-R:1218)
- 18. Sunflower Gold (Sul-R:1333)

Gfe_sof4_2.vp3
4.54x13.53 inches; 26,239 stitches
18 thread changes; 16 colors



- 1. Burnt Toast (Sul-R:1265)
- 2. Dk. Gray Khaki (Sul-R:1270)
- 3. Dewberry (Sul-R:1304)
- 4. Silver (Sul-R:1085)
- 5. Med. Chestnut (Sul-R:1214)
- 6. Taupe (Sul-R:1213)
- 7. Dewberry (Sul-R:1304)
- 8. Moss Green (Sul-R:630)
- 9. Lt. Putty (Sul-R:1229)
- 10. Drab Green (Sul-R:1228)
- 11. Off White (Sul-R:1071)
- 12. Silver Gray (Sul-R:1218)
- 13. Dk. Ecrú (Sul-R:1128)
- 14. Cream (Sul-R:1022)
- 15. Gold (Sul-R:1070)
- 16. Sunflower Gold (Sul-R:1333)

Gfe_sof4_3.vp3
4.33x14.02 inches; 33,566 stitches
16 thread changes; 15 colors



- 1. Burnt Toast (Sul-R:1265)
- 2. Dk. Gray Khaki (Sul-R:1270)
- 3. Drab Green (Sul-R:1228)
- 4. Khaki (Sul-R:1212)
- 5. Moss Green (Sul-R:630)
- 6. Dewberry (Sul-R:1304)
- 7. Silver (Sul-R:1085)
- 8. Med. Chestnut (Sul-R:1214)
- 9. Taupe (Sul-R:1213)
- 10. Dewberry (Sul-R:1304)
- 11. Lt. Putty (Sul-R:1229)
- 12. Lt. Putty (Sul-R:1229)
- 13. Putty (Sul-R:1508)
- 14. Off White (Sul-R:1071)
- 15. Silver Gray (Sul-R:1218)
- 16. Dk. Ecrú (Sul-R:1128)
- 17. Cream (Sul-R:1022)
- 18. Gold (Sul-R:1070)
- 19. Sunflower Gold (Sul-R:1333)

Gfe_sof4_4.vp3
4.83x12.68 inches; 35,284 stitches
19 thread changes; 17 colors

Symphony of Flowers 4



- 1. Burnt Toast (Sul-R:1265)
- 2. Dk. Gray Khaki (Sul-R:1270)
- 3. Khaki (Sul-R:1212)
- 4. Drab Green (Sul-R:1228)
- 5. Dewberry (Sul-R:1304)
- 6. Silver (Sul-R:1085)
- 7. Med. Chestnut (Sul-R:1214)
- 8. Taupe (Sul-R:1213)
- 9. Dewberry (Sul-R:1304)
- 10. Moss Green (Sul-R:630)
- 11. Lt. Putty (Sul-R:1229)
- 12. Lt. Putty (Sul-R:1229)
- 13. Putty (Sul-R:1508)
- 14. Off White (Sul-R:1071)
- 15. Silver Gray (Sul-R:1218)
- 16. Dk. Ecru (Sul-R:1128)
- 17. Cream (Sul-R:1022)
- 18. Gold (Sul-R:1070)
- 19. Sunflower Gold (Sul-R:1333)

Gfe_sof4_5.vp3

5.59x11.70 inches; 34,321 stitches
19 thread changes; 17 colors



- 1. Burnt Toast (Sul-R:1265)
- 2. Dk. Gray Khaki (Sul-R:1270)
- 3. Moss Green (Sul-R:630)
- 4. Dewberry (Sul-R:1304)
- 5. Silver (Sul-R:1085)
- 6. Med. Chestnut (Sul-R:1214)
- 7. Taupe (Sul-R:1213)
- 8. Dewberry (Sul-R:1304)
- 9. Lt. Putty (Sul-R:1229)
- 10. Lt. Putty (Sul-R:1229)
- 11. Putty (Sul-R:1508)
- 12. Off White (Sul-R:1071)
- 13. Silver Gray (Sul-R:1218)
- 14. Dk. Ecru (Sul-R:1128)
- 15. Cream (Sul-R:1022)
- 16. Gold (Sul-R:1070)
- 17. Sunflower Gold (Sul-R:1333)

Gfe_sof4_6.vp3

5.32x12.33 inches; 43,204 stitches
17 thread changes; 15 colors



- 1. Burnt Toast (Sul-R:1265)
- 2. Dk. Gray Khaki (Sul-R:1270)
- 3. Moss Green (Sul-R:630)
- 4. Dewberry (Sul-R:1304)
- 5. Silver (Sul-R:1085)
- 6. Med. Chestnut (Sul-R:1214)
- 7. Taupe (Sul-R:1213)
- 8. Dewberry (Sul-R:1304)
- 9. Lt. Putty (Sul-R:1229)
- 10. Lt. Putty (Sul-R:1229)
- 11. Putty (Sul-R:1508)
- 12. Off White (Sul-R:1071)
- 13. Silver Gray (Sul-R:1218)
- 14. Dk. Ecru (Sul-R:1128)
- 15. Cream (Sul-R:1022)
- 16. Gold (Sul-R:1070)
- 17. Sunflower Gold (Sul-R:1333)

Gfe_sof4_7.vp3

5.33x12.43 inches; 43,209 stitches
17 thread changes; 15 colors



- 1. Burnt Toast (Sul-R:1265)
- 2. Dk. Gray Khaki (Sul-R:1270)
- 3. Khaki (Sul-R:1212)
- 4. Dewberry (Sul-R:1304)
- 5. Silver (Sul-R:1085)
- 6. Med. Chestnut (Sul-R:1214)
- 7. Taupe (Sul-R:1213)
- 8. Dewberry (Sul-R:1304)
- 9. Moss Green (Sul-R:630)
- 10. Lt. Putty (Sul-R:1229)
- 11. Lt. Putty (Sul-R:1229)
- 12. Putty (Sul-R:1508)
- 13. Off White (Sul-R:1071)
- 14. Silver Gray (Sul-R:1218)
- 15. Dk. Ecru (Sul-R:1128)
- 16. Drab Green (Sul-R:1228)
- 17. Cream (Sul-R:1022)
- 18. Gold (Sul-R:1070)
- 19. Sunflower Gold (Sul-R:1333)

Gfe_sof4_8.vp3

5.77x12.02 inches; 36,407 stitches
19 thread changes; 17 colors