

## Jane's White Work 1

Scroll down to view all the sets in this collection

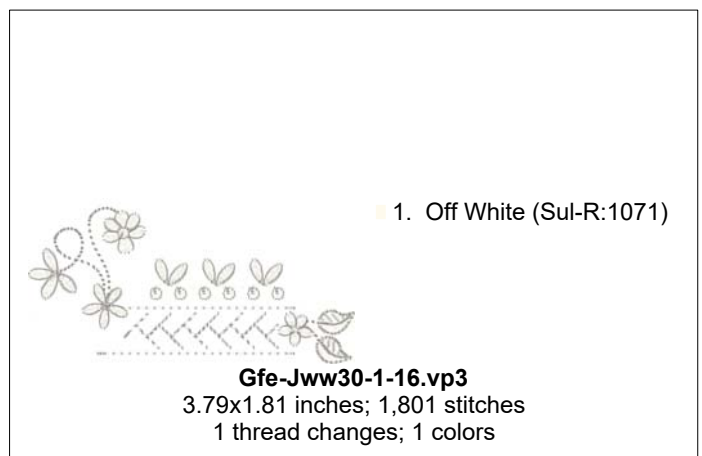

# Jane's White Work 1

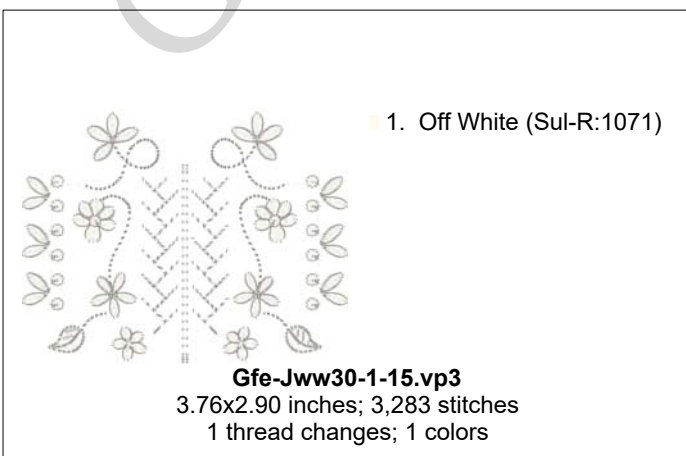
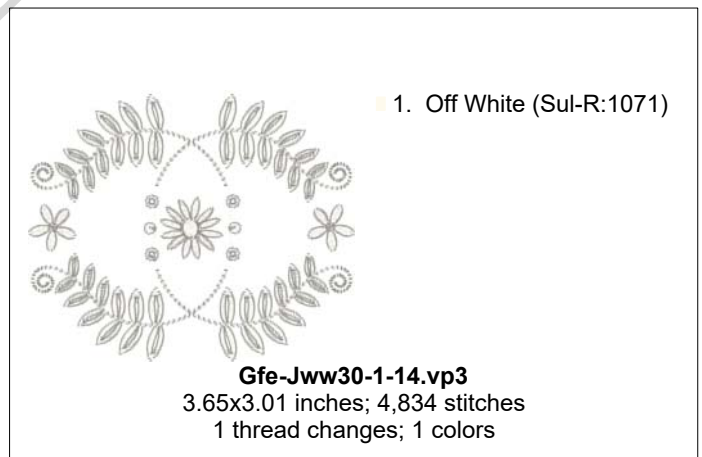
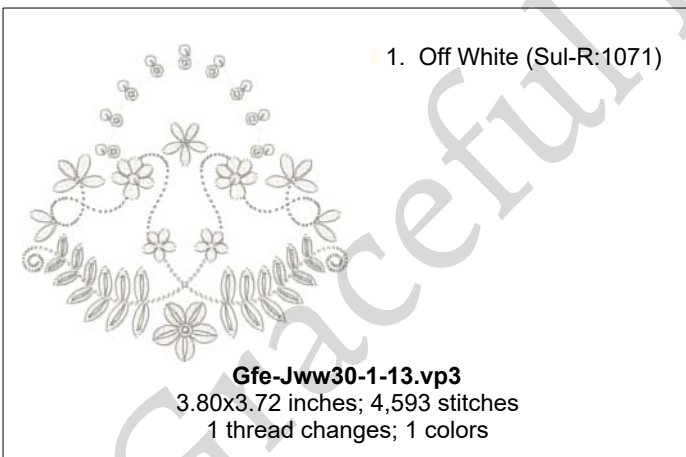
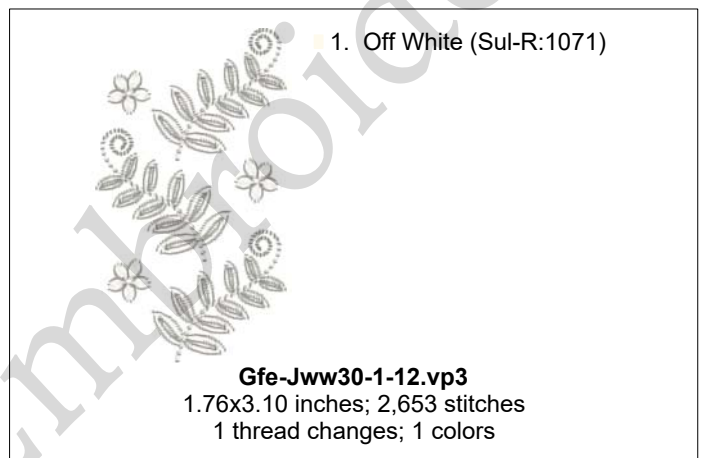
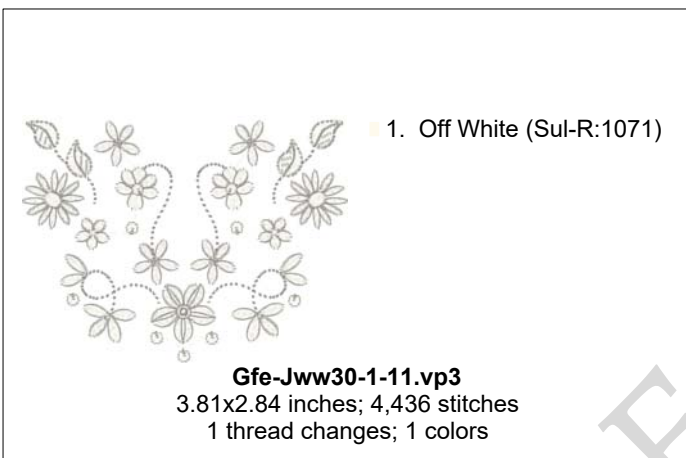
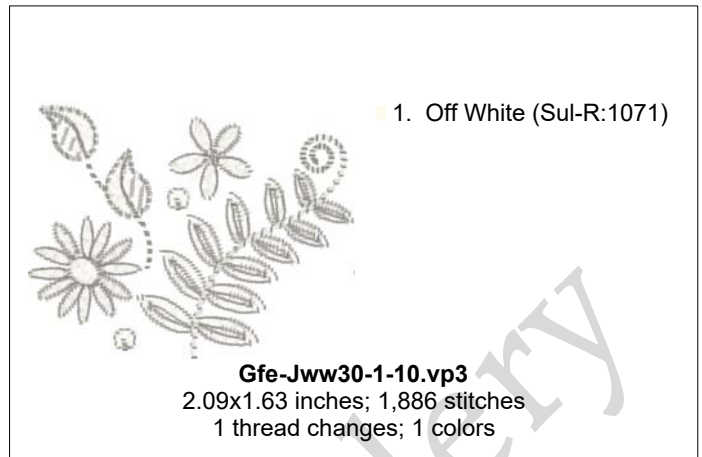
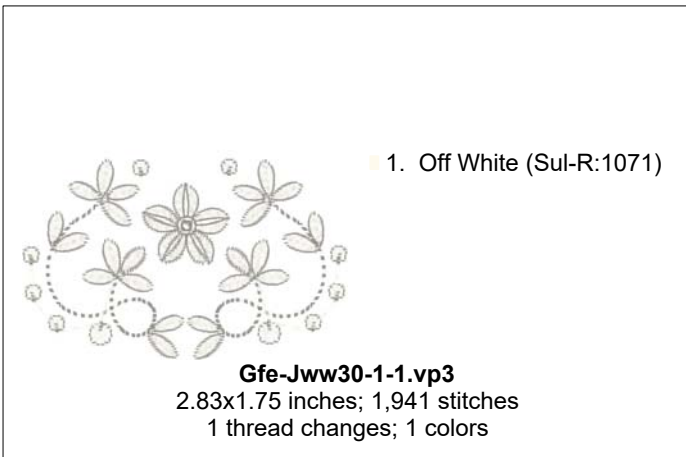
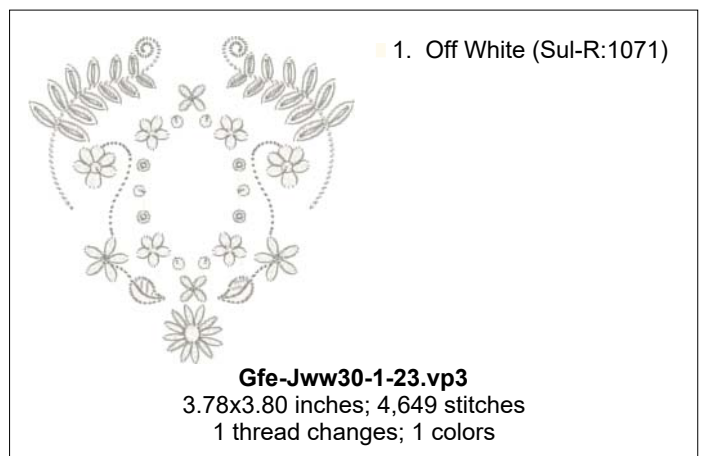
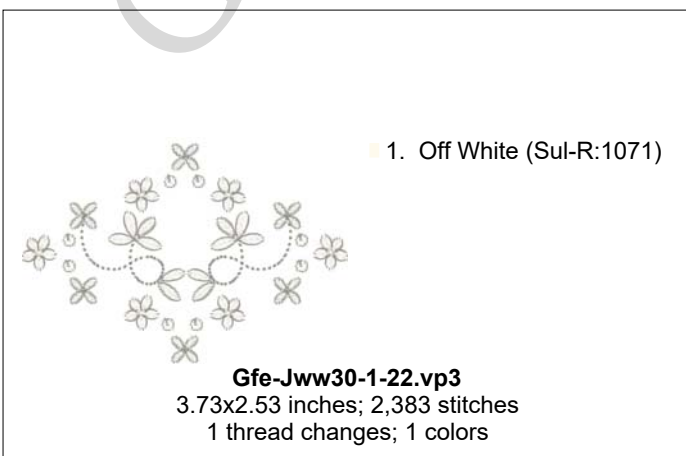
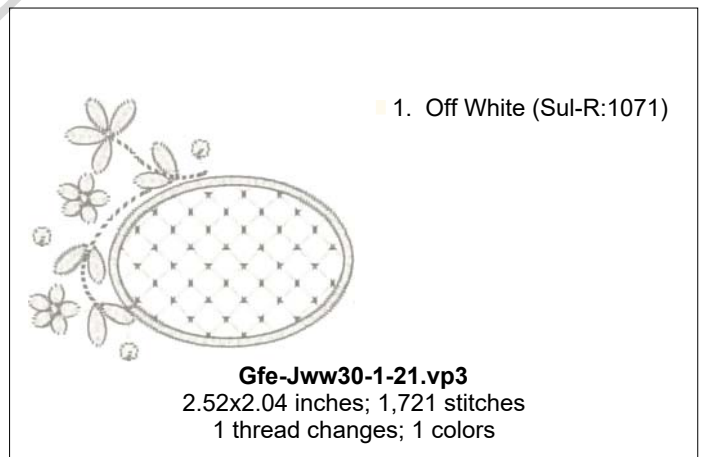
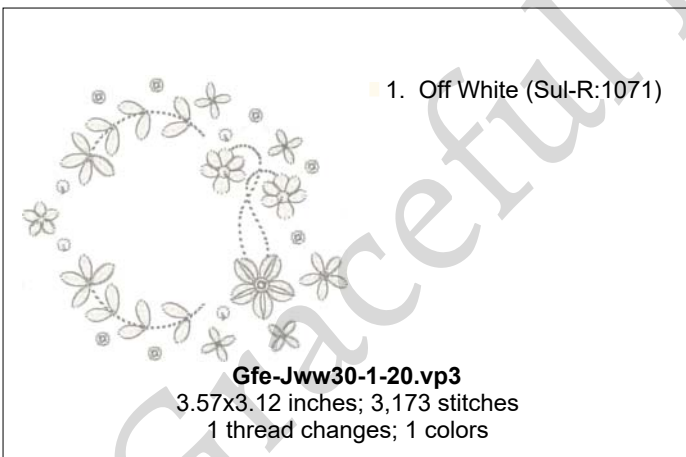
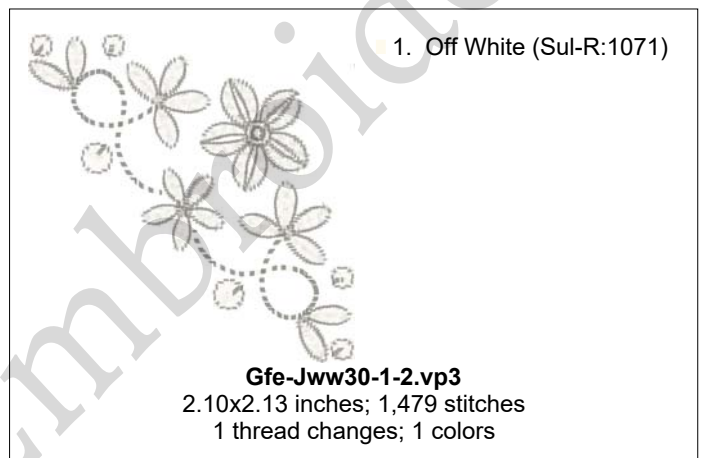
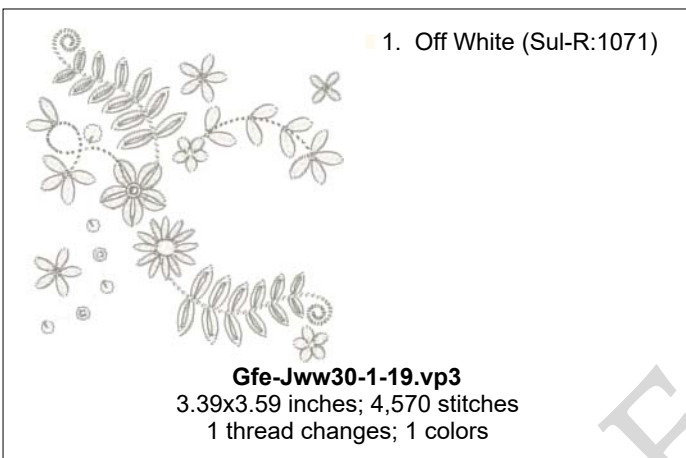
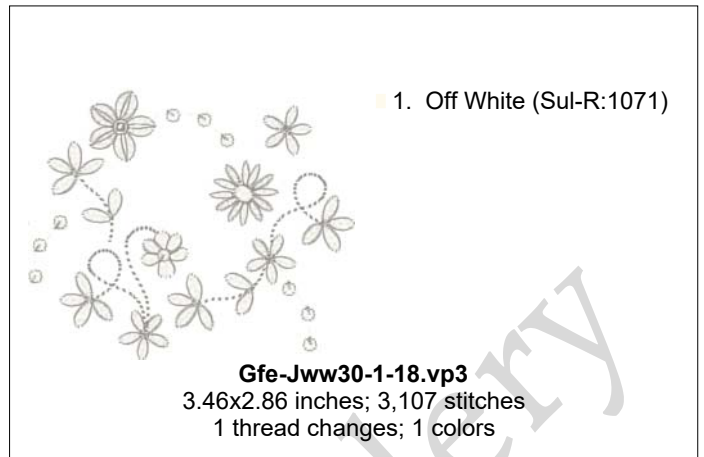
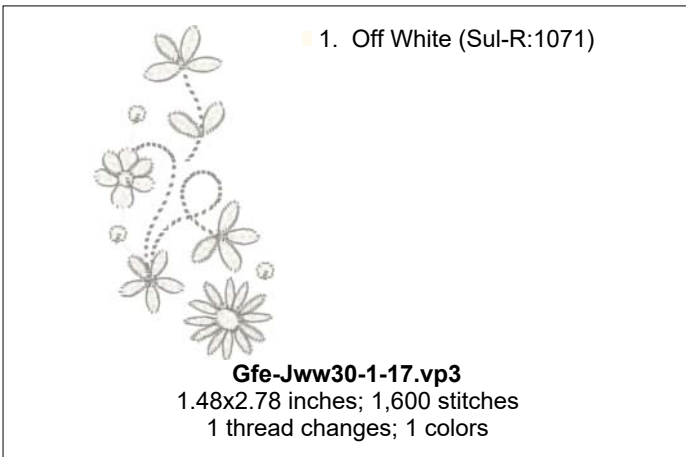

## Jane's White Work 1

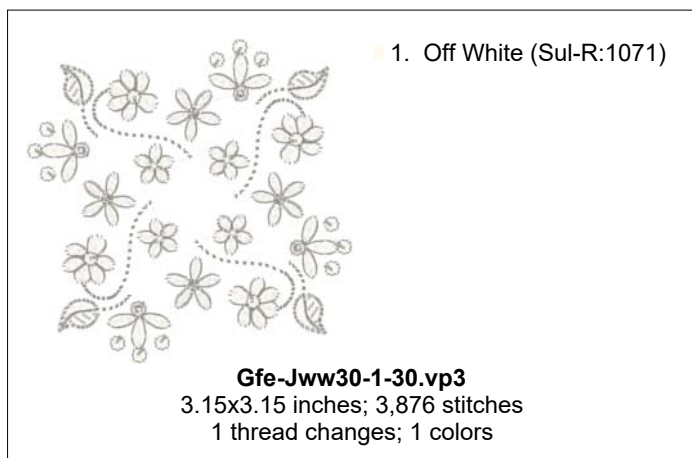
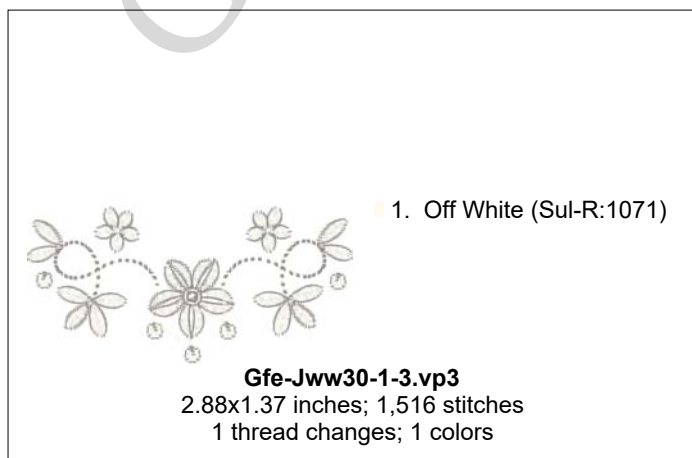
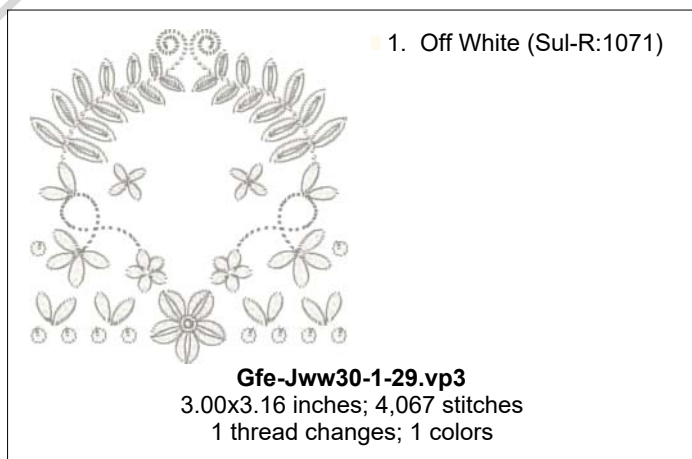
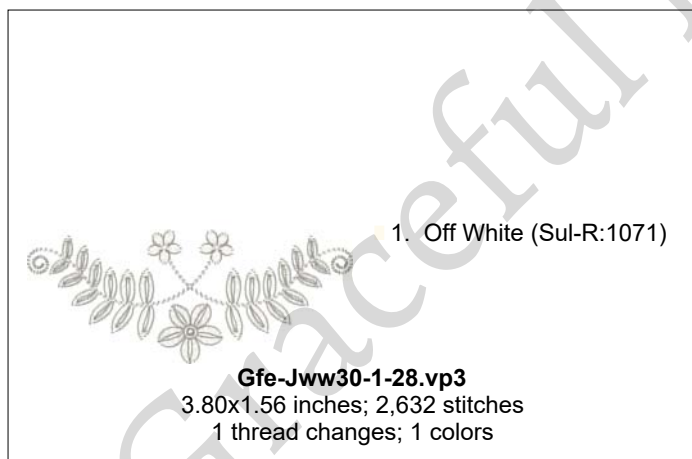
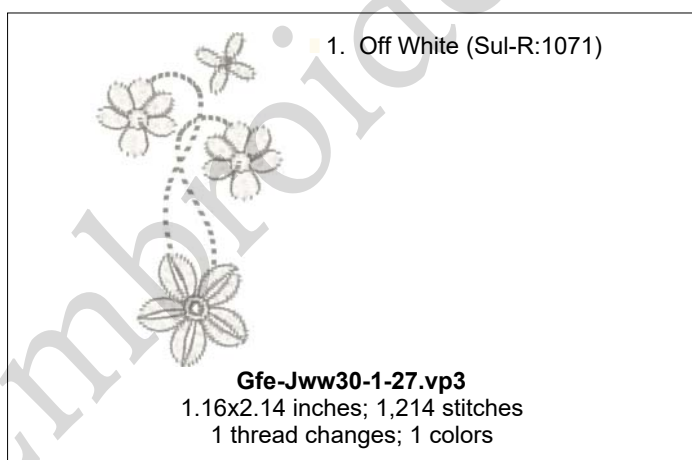
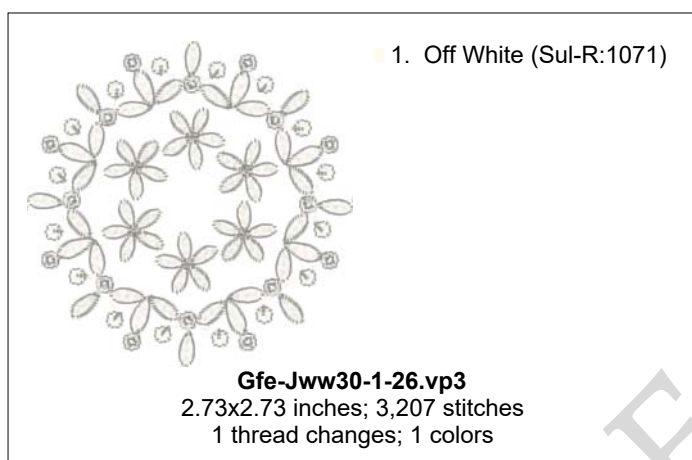
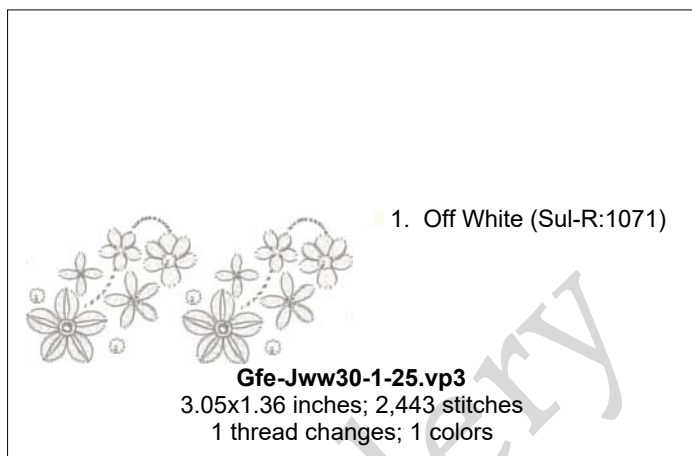
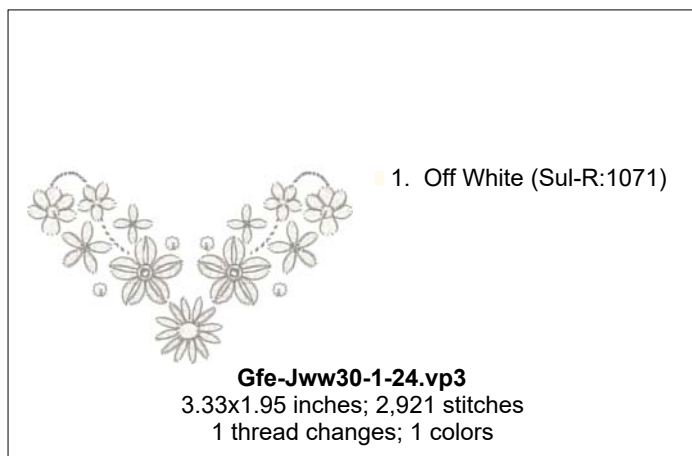

## Jane's White Work 1

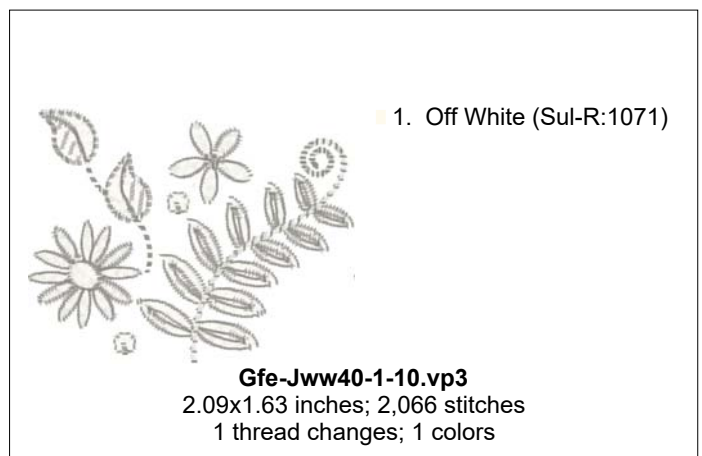
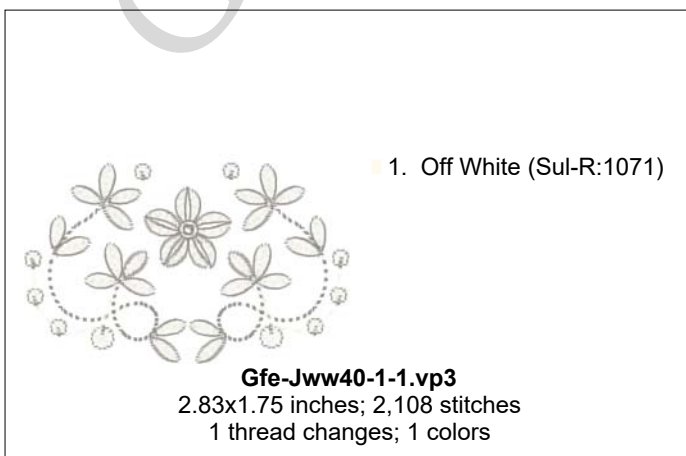
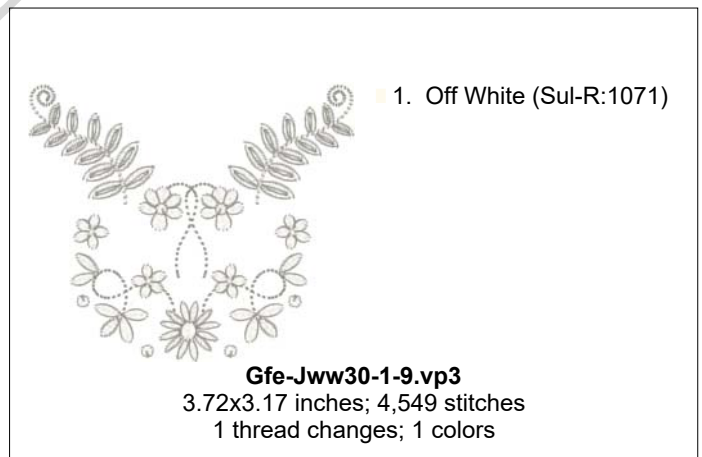
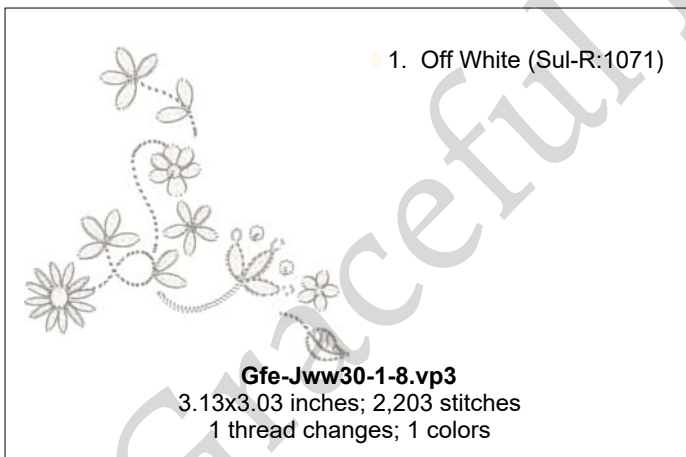
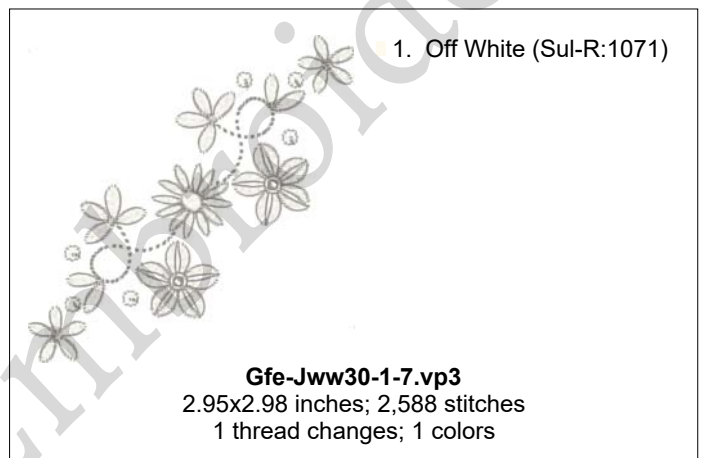
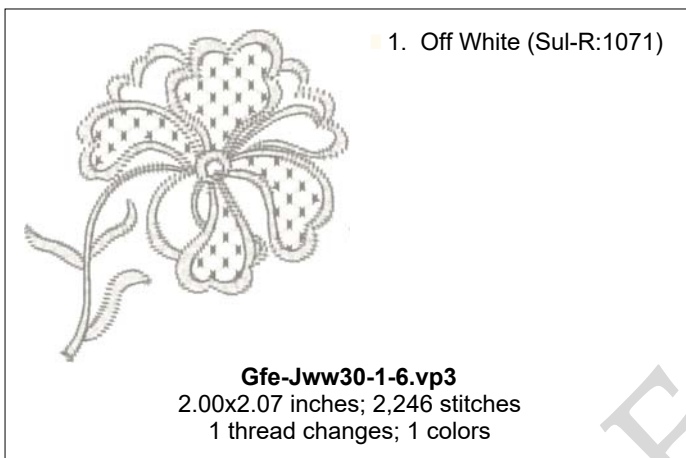
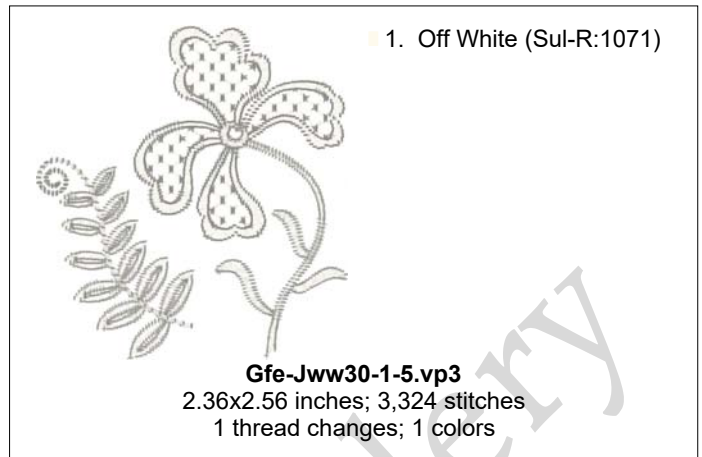
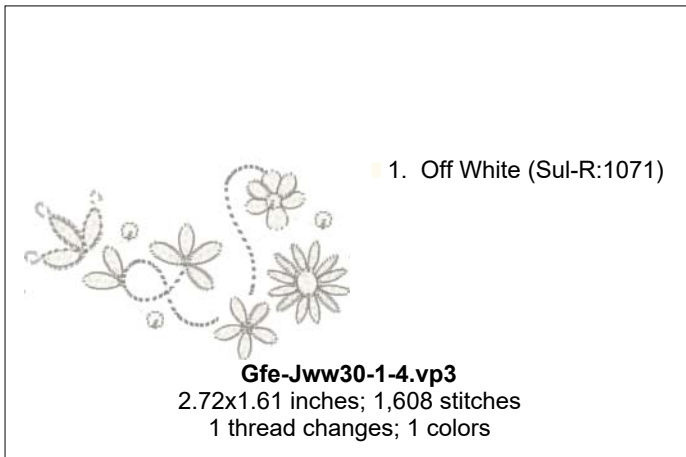

# Jane's White Work 1

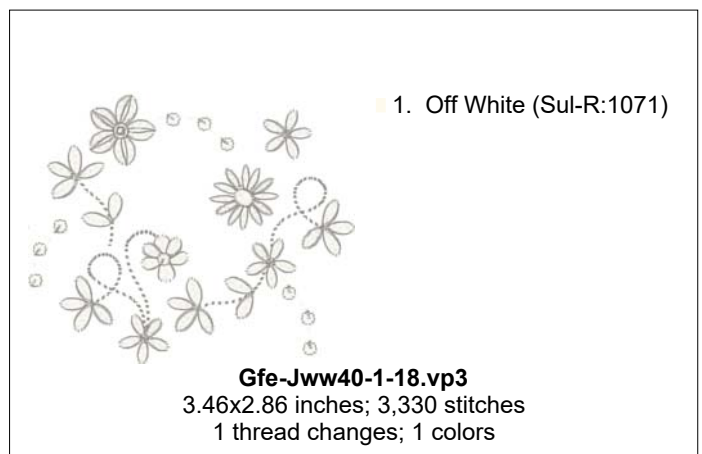
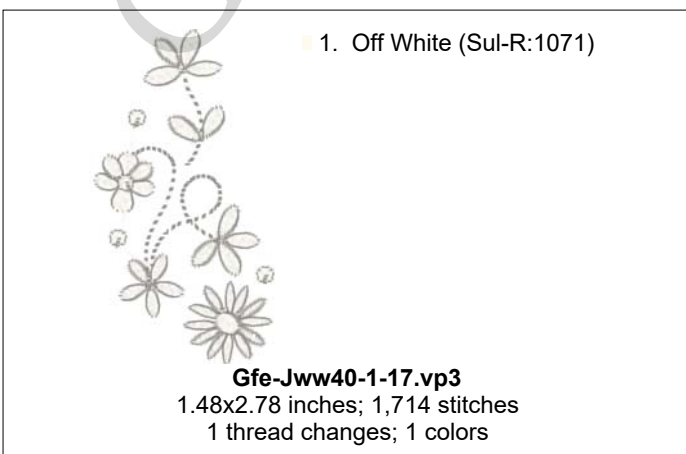
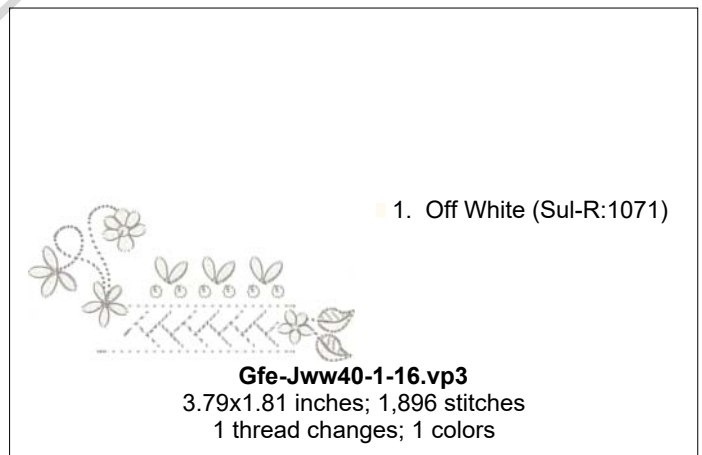
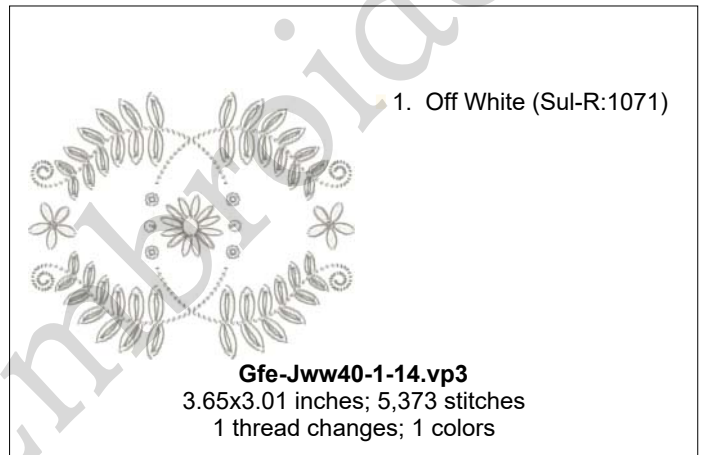
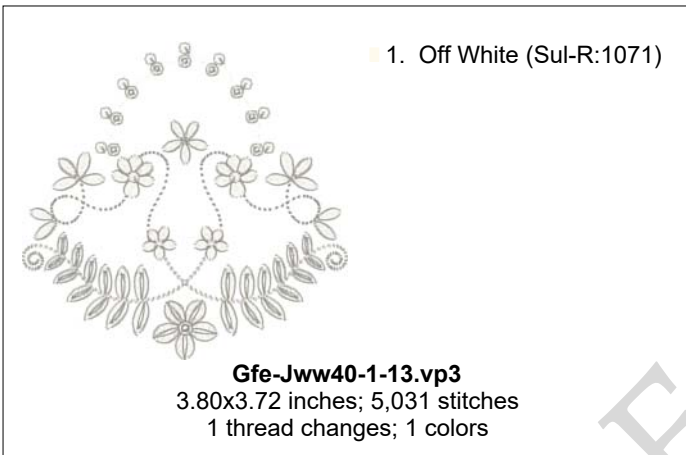
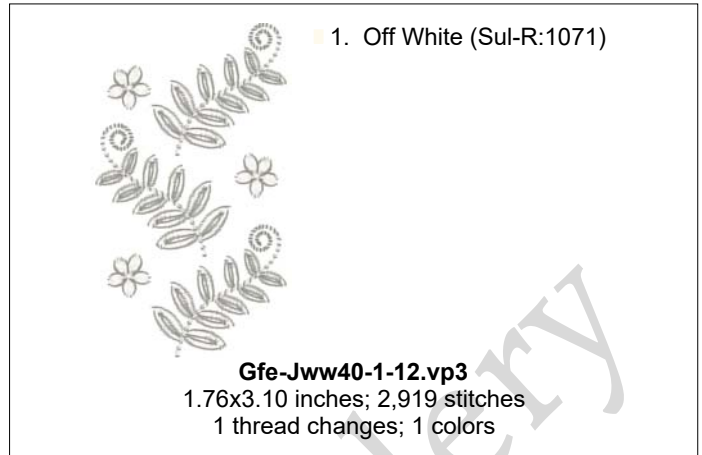
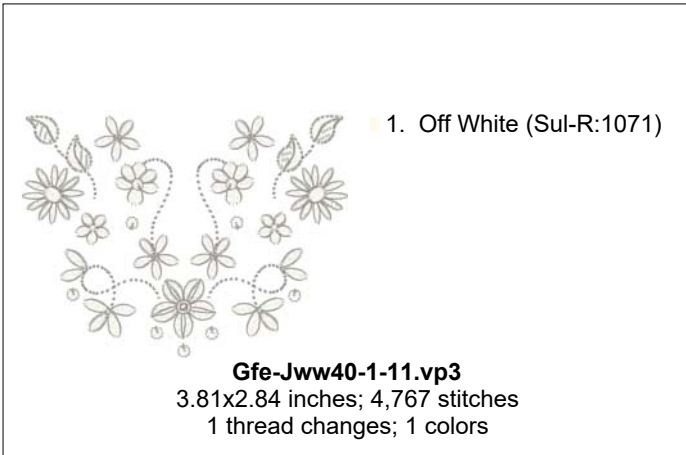

## Jane's White Work 1

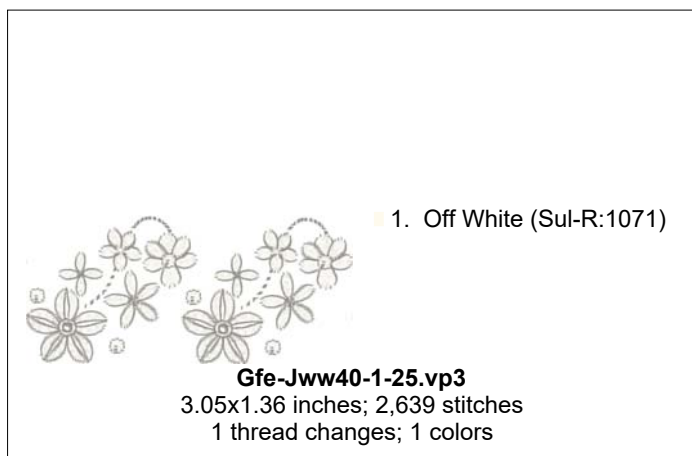
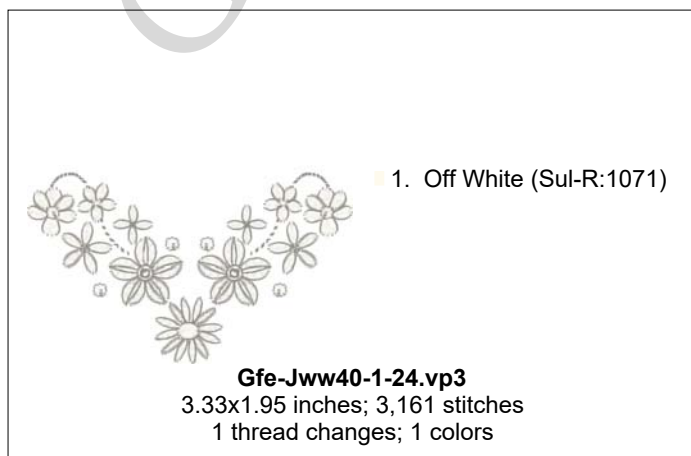
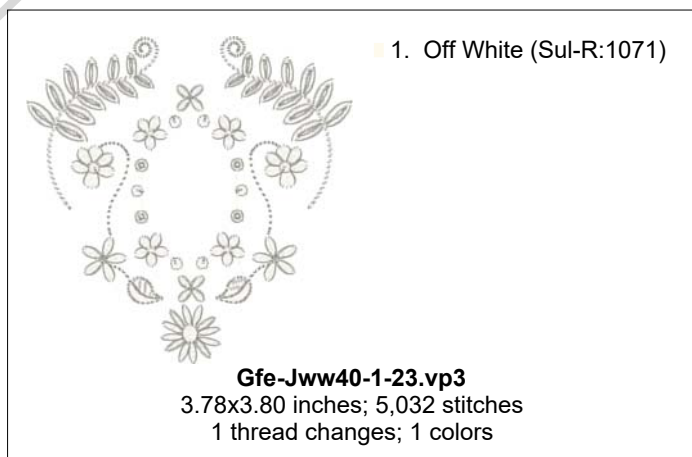
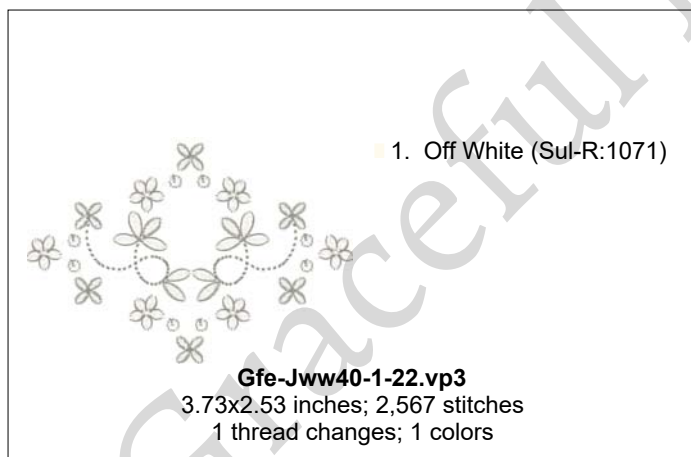
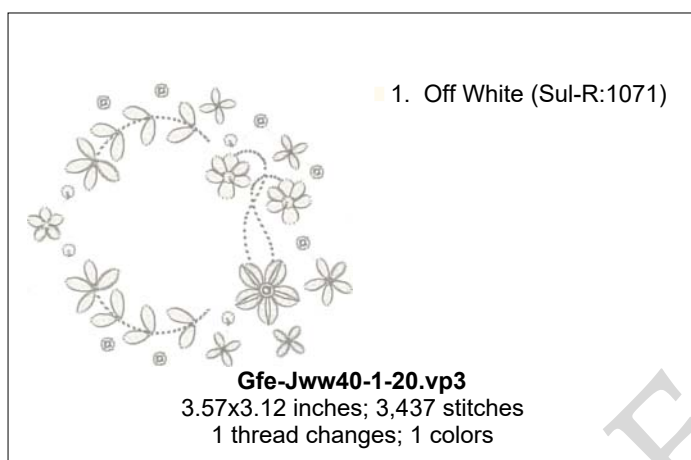
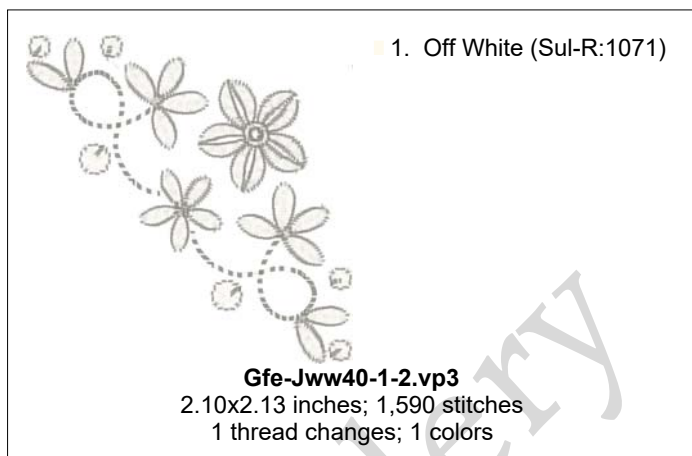
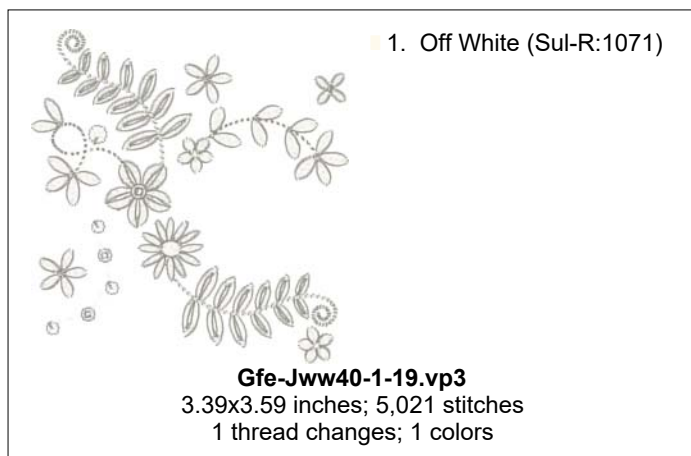

## Jane's White Work 1

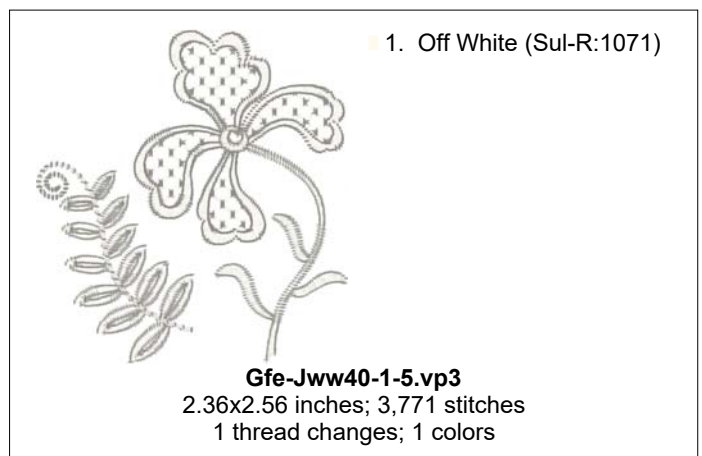
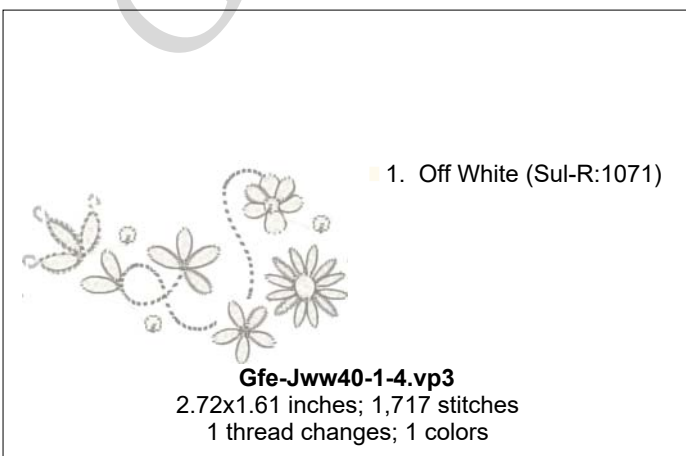
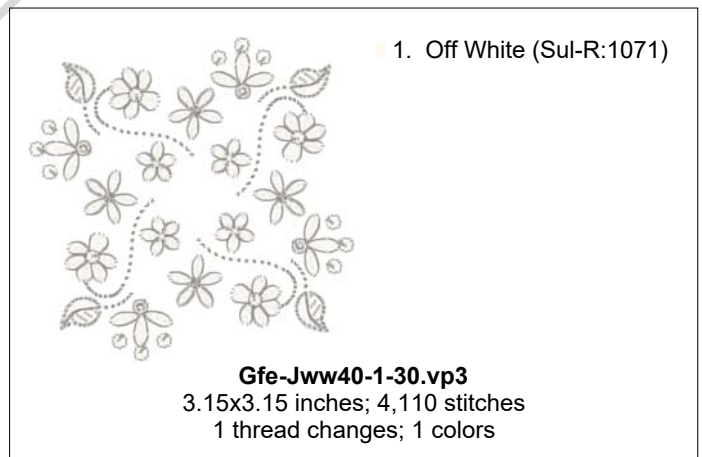
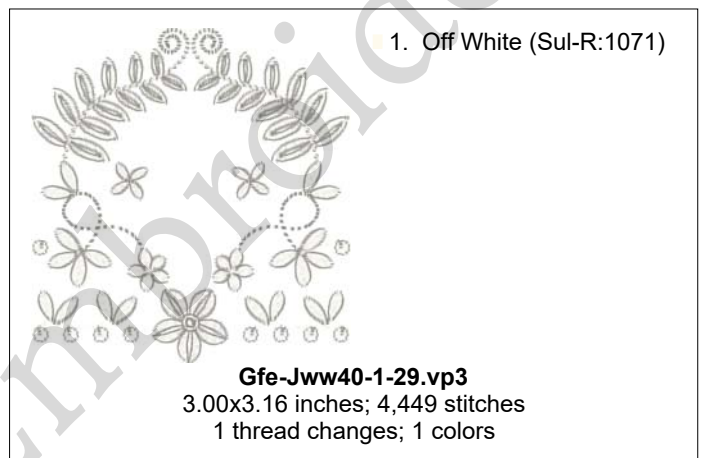
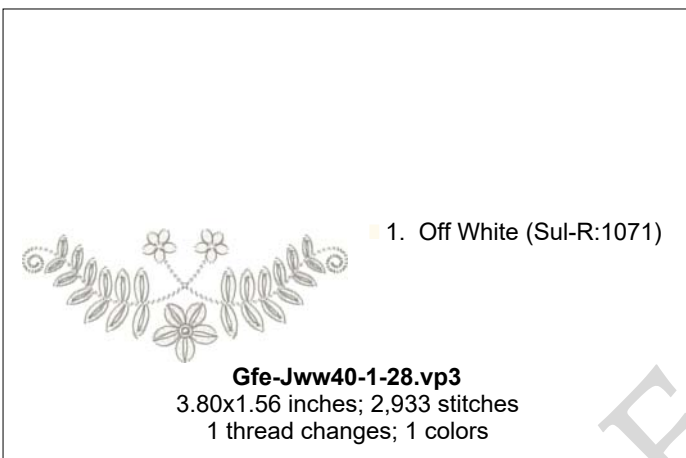
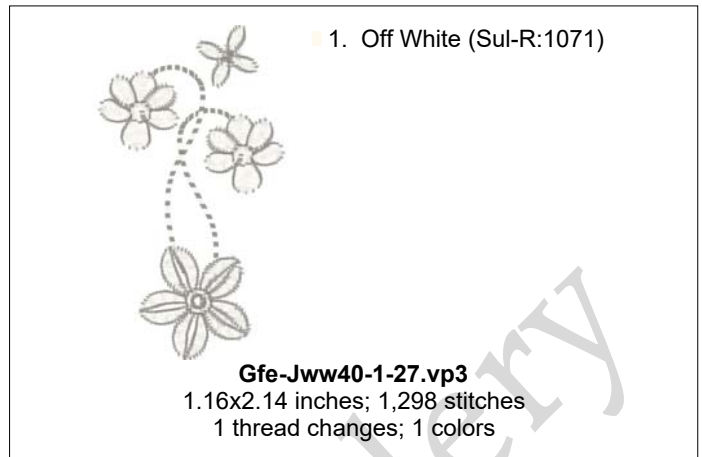
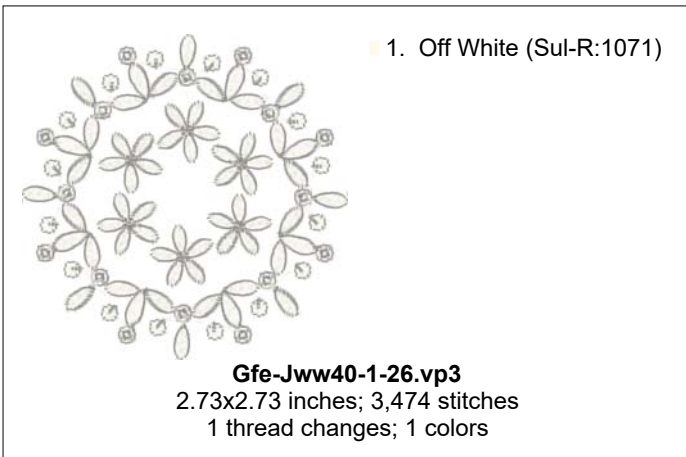

# Jane's White Work 1

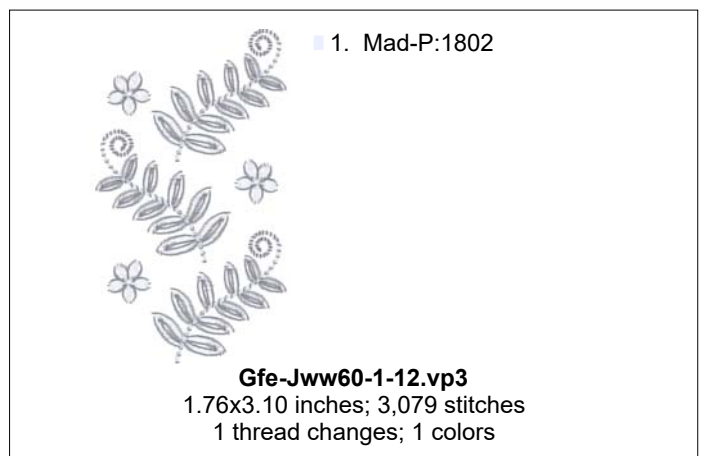
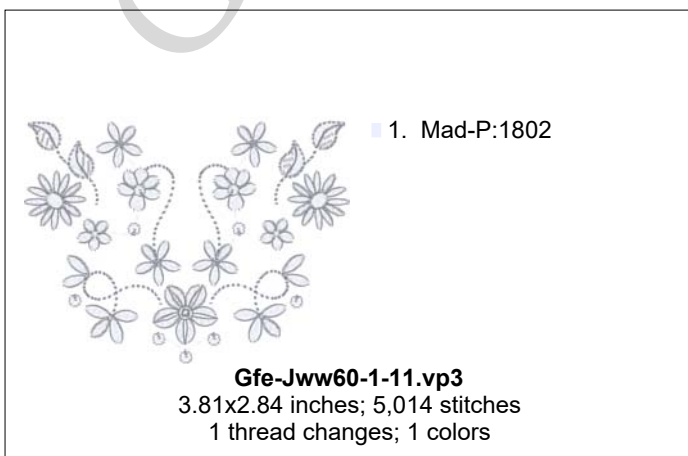
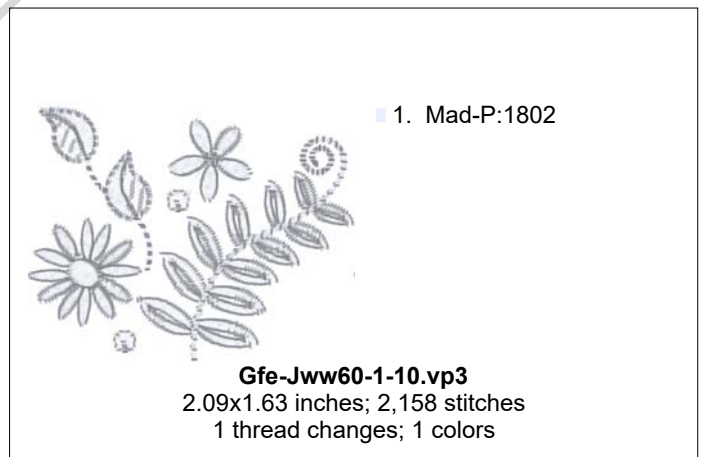
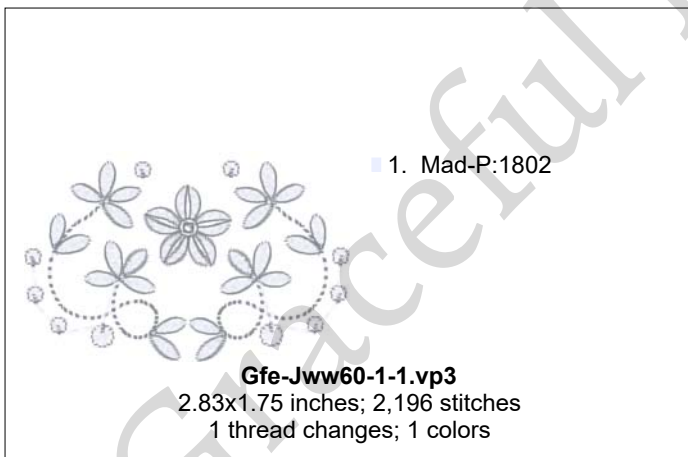
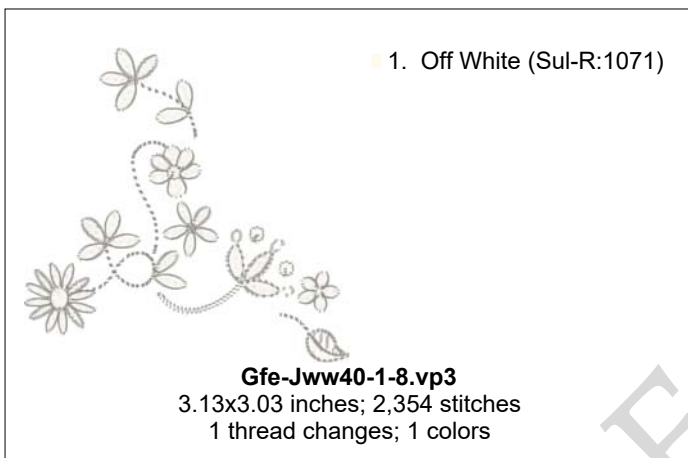
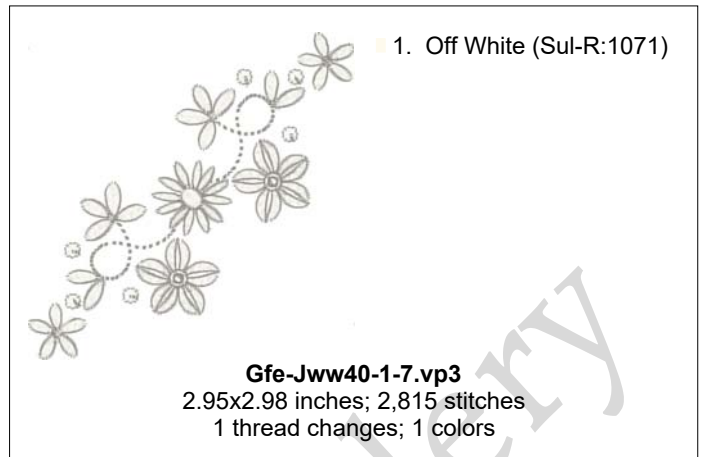
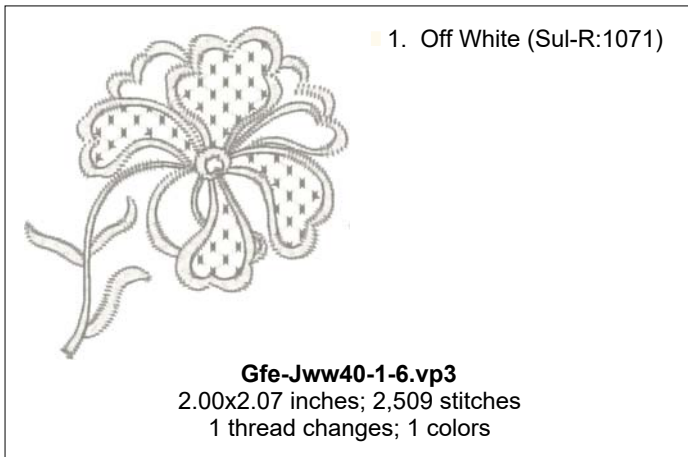



## Jane's White Work 1

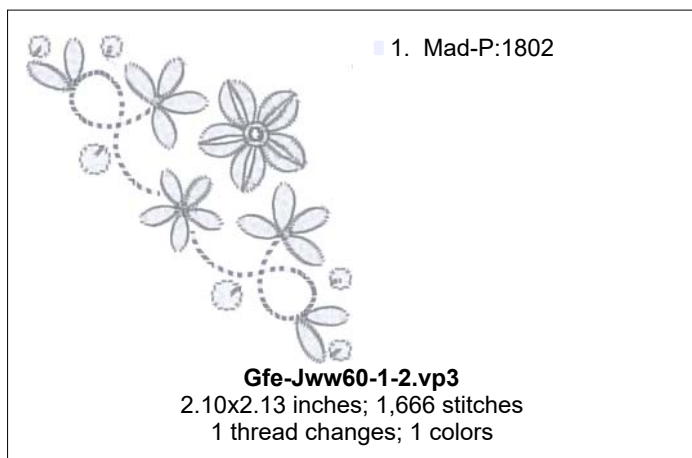
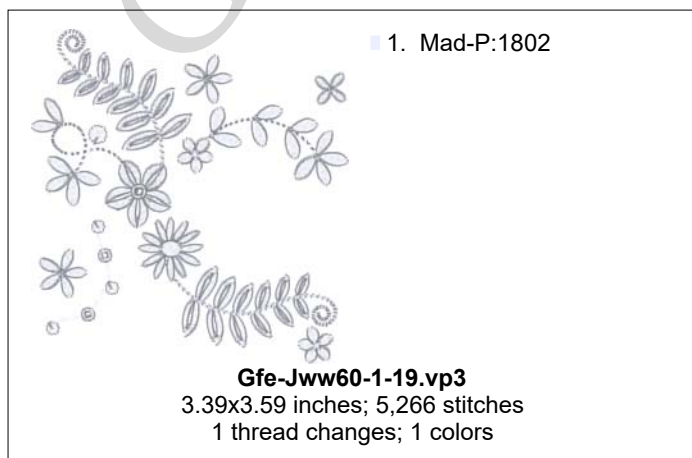
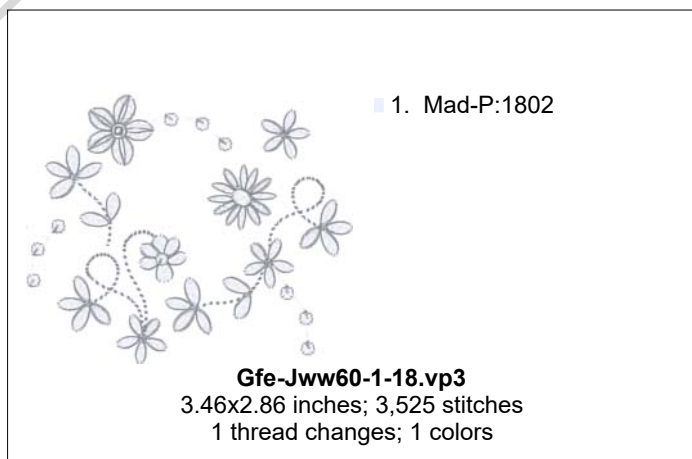
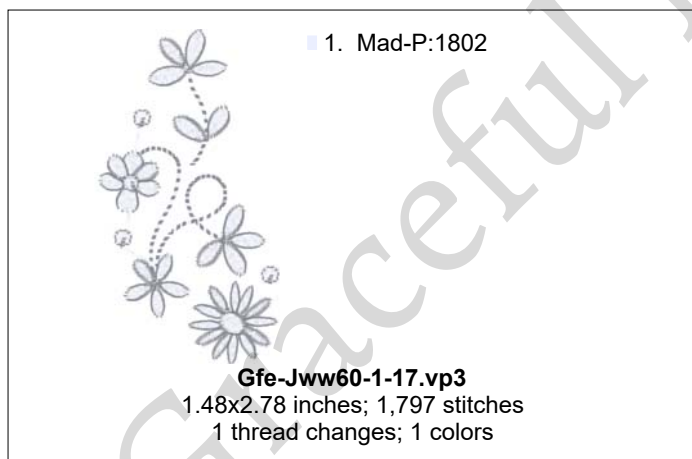
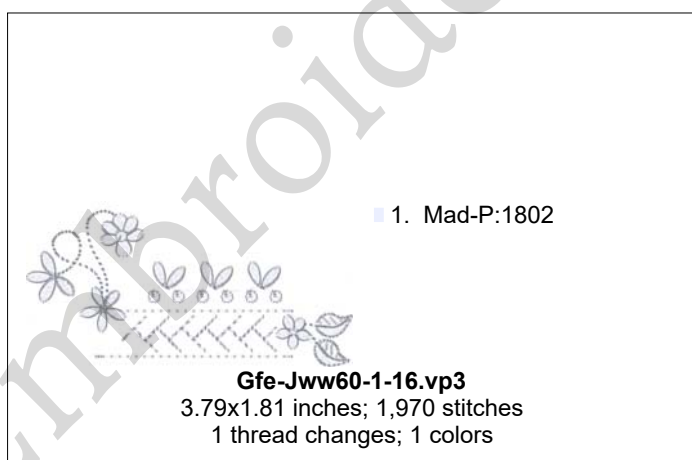
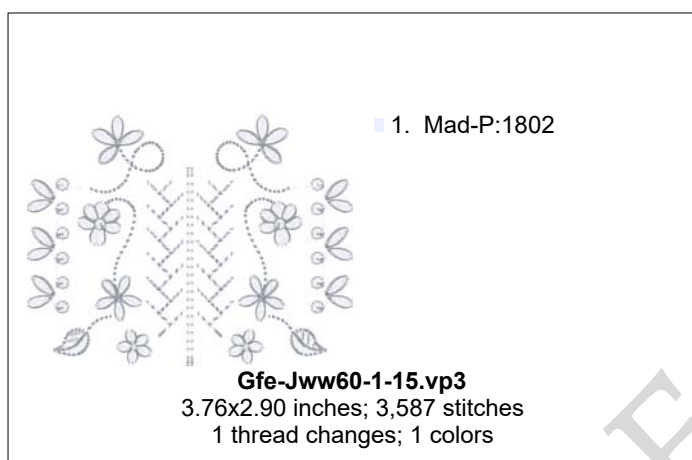
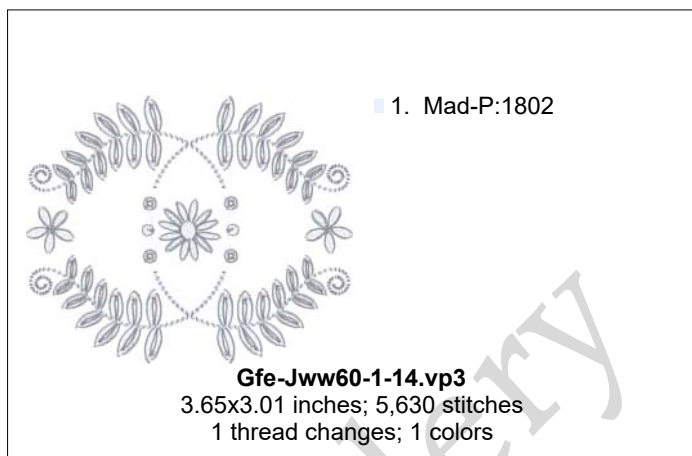
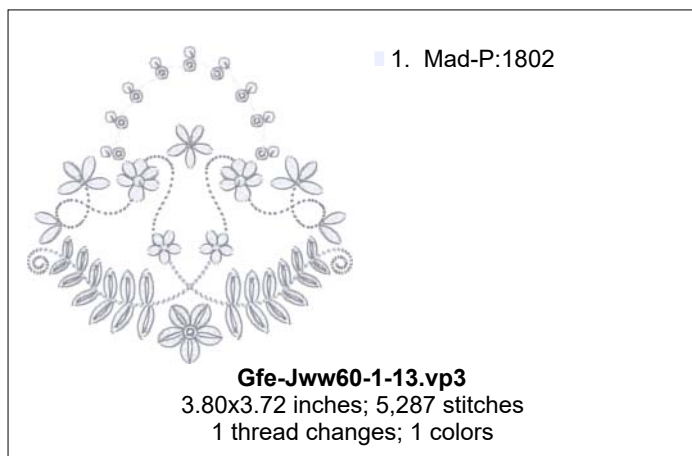

# Jane's White Work 1

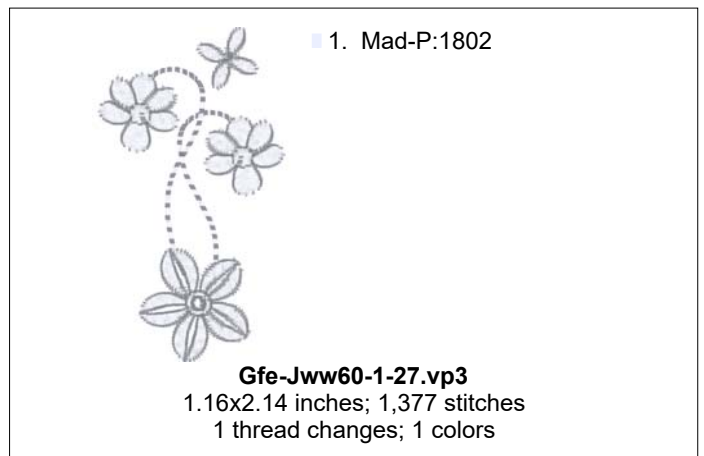
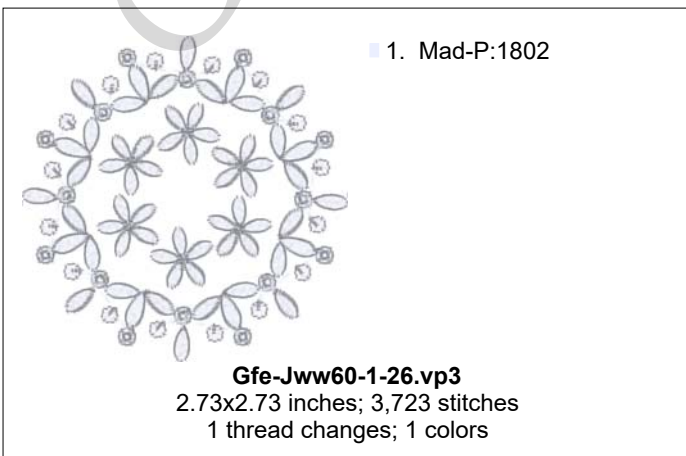
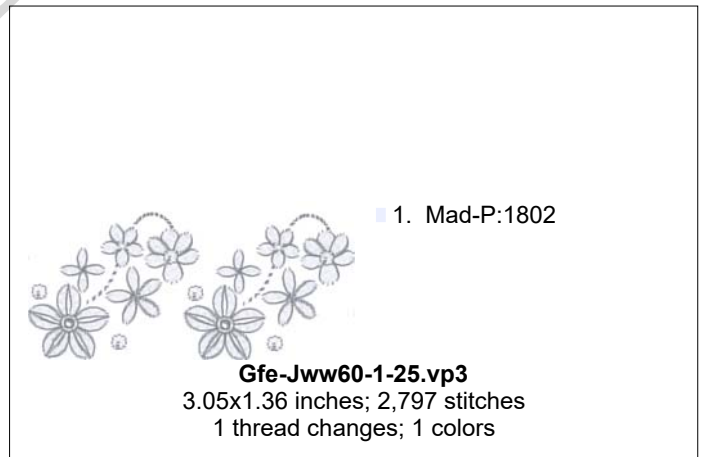
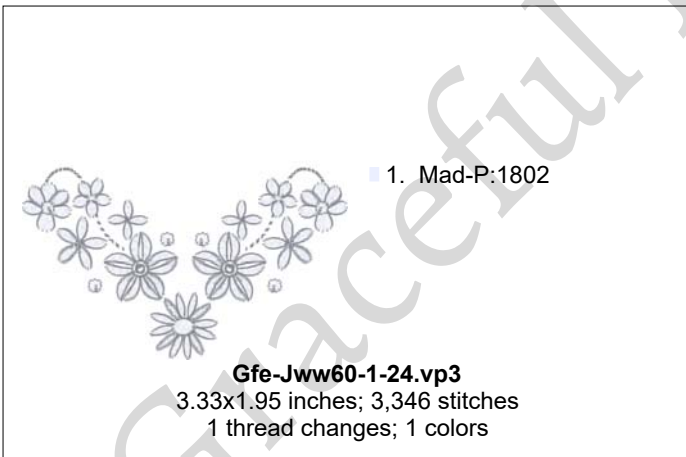
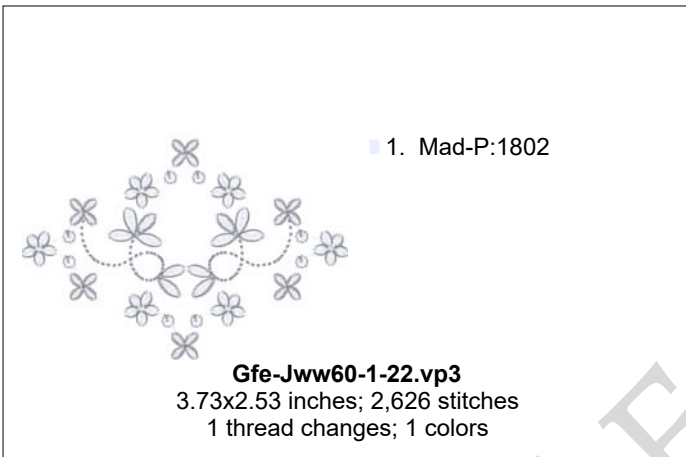
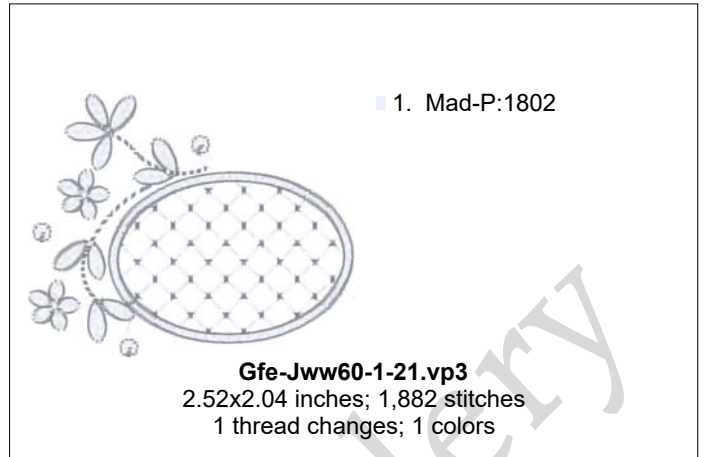
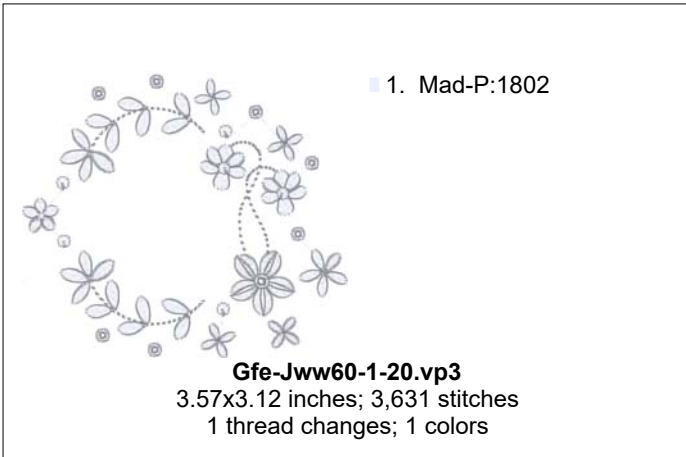

# Jane's White Work 1

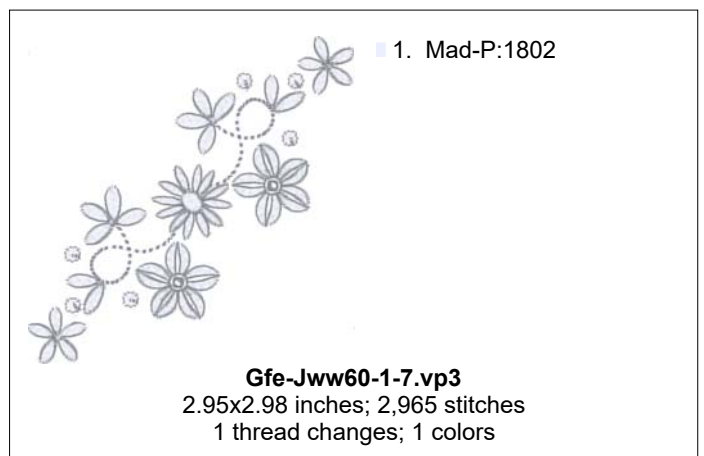
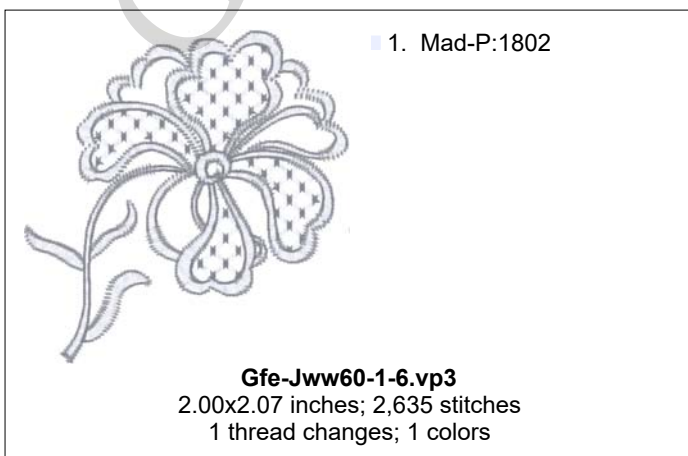
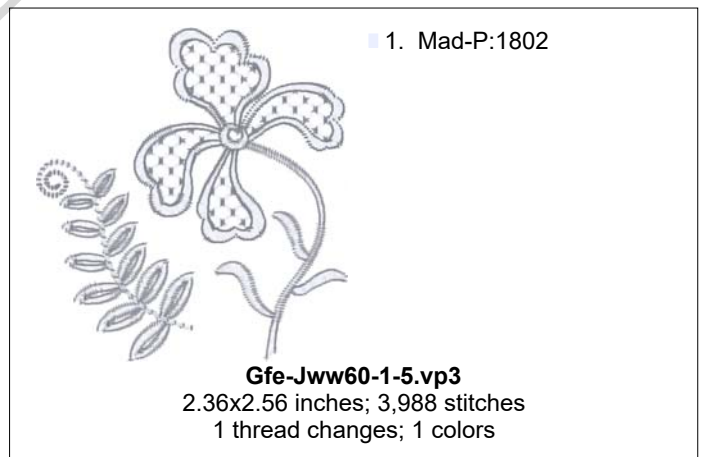
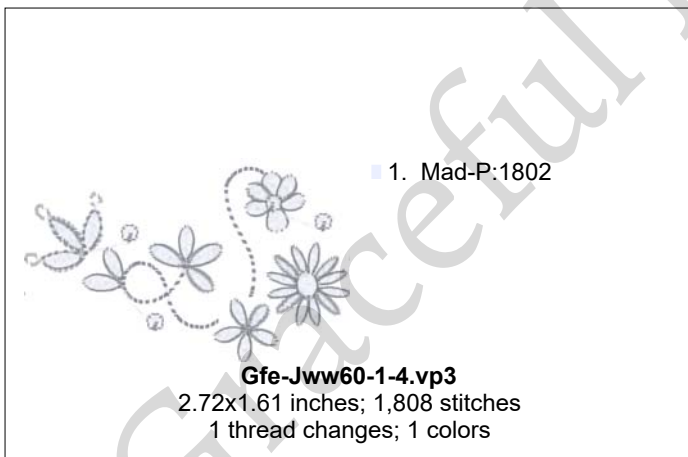
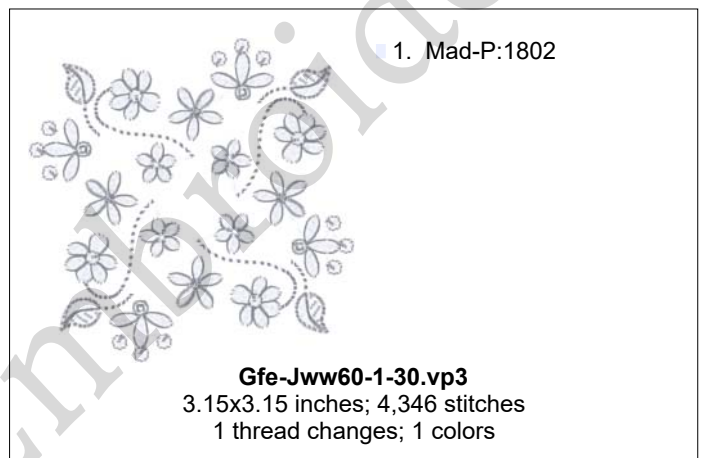
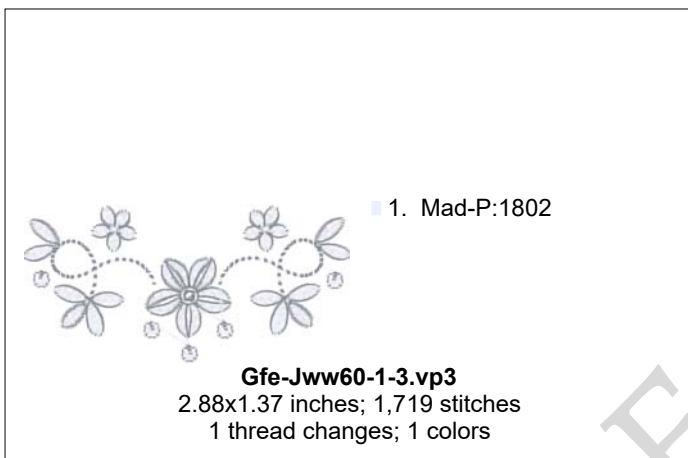
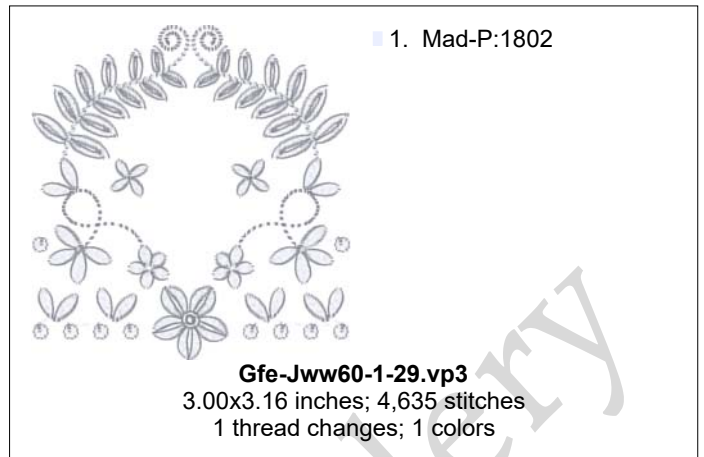
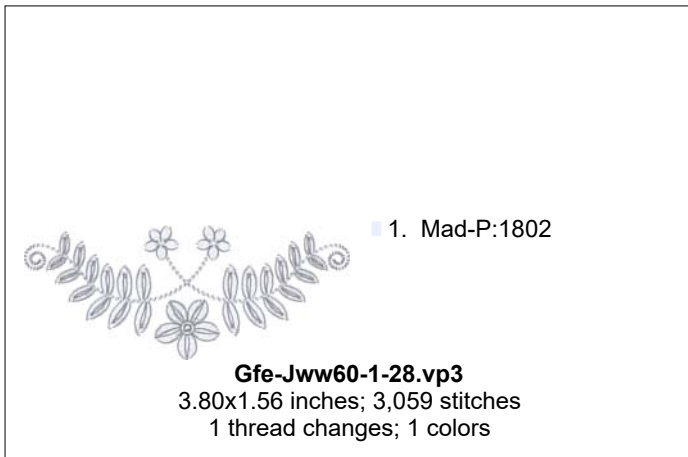

**Jane's White Work 1**

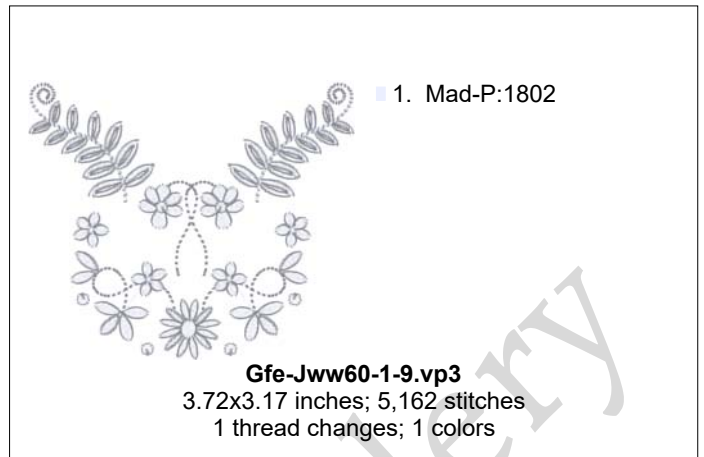
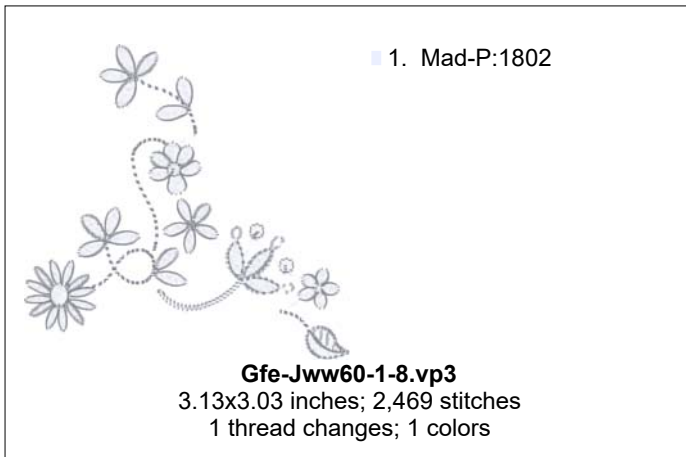

© Graceful Embroidery February 2018

Graceful Embroidery

## Jane's White Work 2



■ 1. Off White (Sul-R:1071)

**Gfe-Jww30-2-1.vp3**

3.56x6.96 inches; 8,840 stitches  
1 thread changes; 1 colors



■ 1. Off White (Sul-R:1071)

**Gfe-Jww30-2-10.vp3**

4.88x4.87 inches; 8,705 stitches  
1 thread changes; 1 colors



■ 1. Off White (Sul-R:1071)

**Gfe-Jww30-2-11.vp3**

2.78x5.01 inches; 5,986 stitches  
1 thread changes; 1 colors

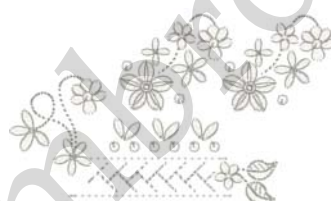

■ 1. Off White (Sul-R:1071)

**Gfe-Jww30-2-12.vp3**

4.61x2.69 inches; 4,242 stitches  
1 thread changes; 1 colors



■ 1. Off White (Sul-R:1071)

**Gfe-Jww30-2-13.vp3**

3.13x6.87 inches; 6,514 stitches  
1 thread changes; 1 colors



■ 1. Off White (Sul-R:1071)

**Gfe-Jww30-2-14.vp3**

3.59x5.34 inches; 4,861 stitches  
1 thread changes; 1 colors



■ 1. Off White (Sul-R:1071)

■ 2. Off White (Sul-R:1071)

■ 3. Off White (Sul-R:1071)

**Gfe-Jww30-2-15.vp3**

5.00x5.08 inches; 12,232 stitches  
3 thread changes; 1 colors



■ 1. Off White (Sul-R:1071)

**Gfe-Jww30-2-16.vp3**

2.73x4.49 inches; 5,570 stitches  
1 thread changes; 1 colors

## Jane's White Work 2

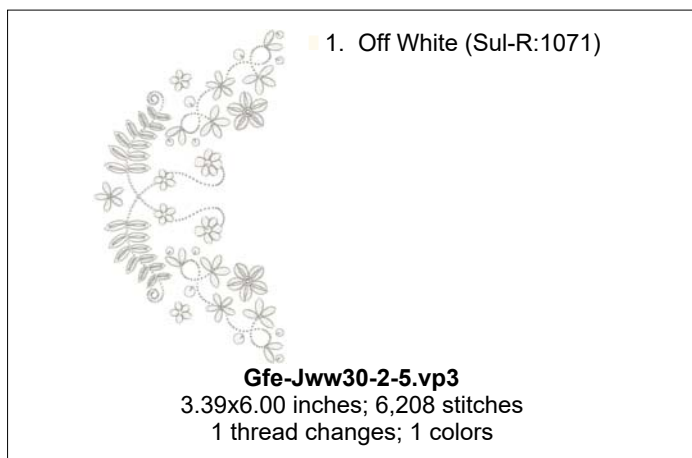
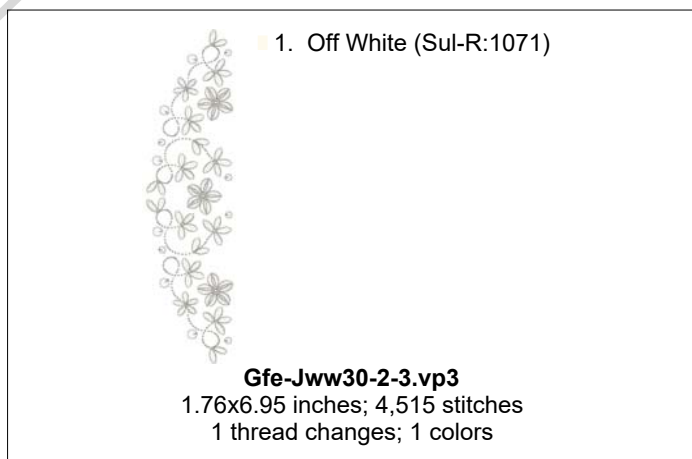
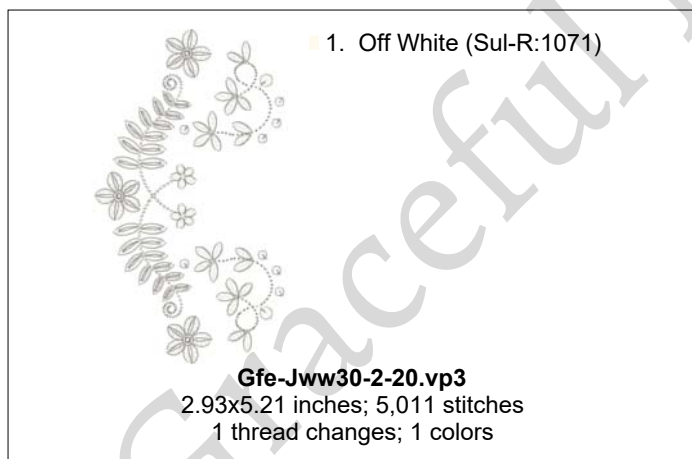
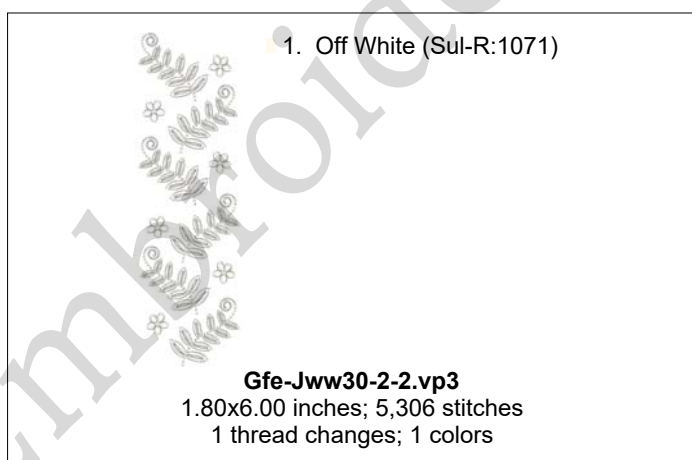
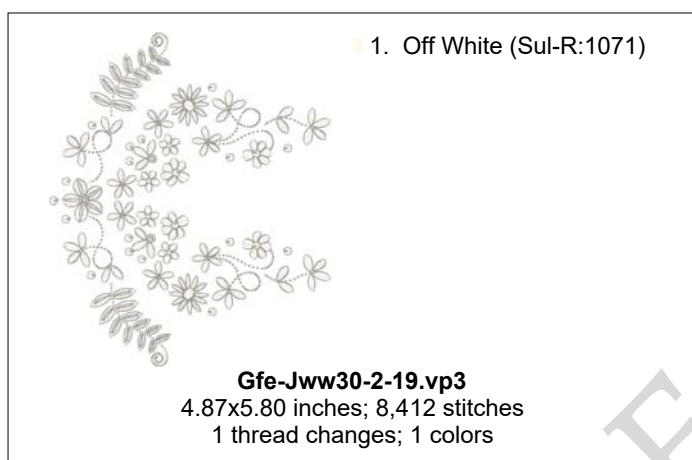
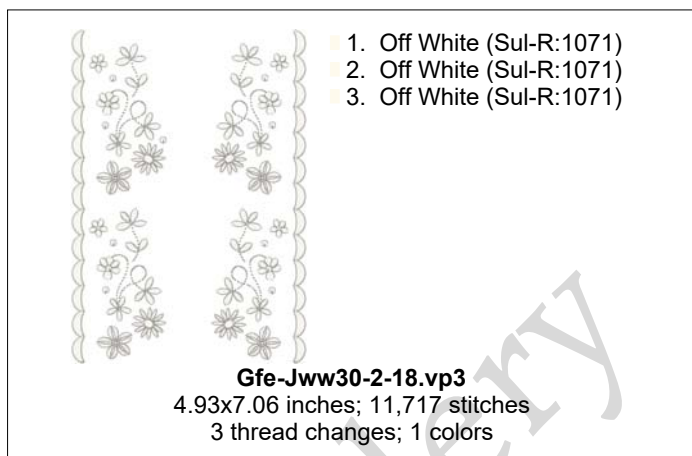
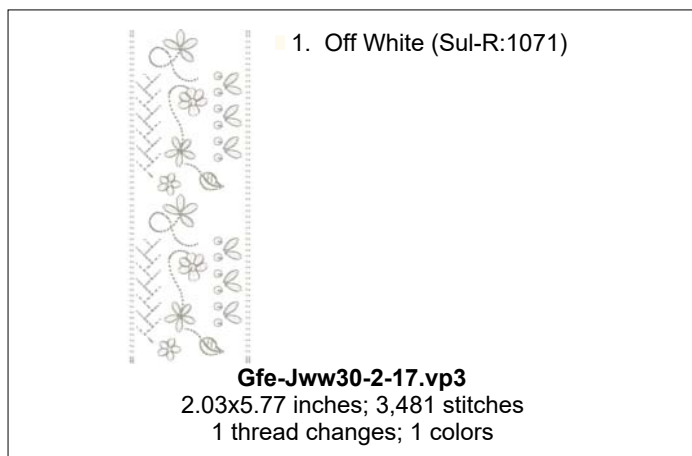

## Jane's White Work 2

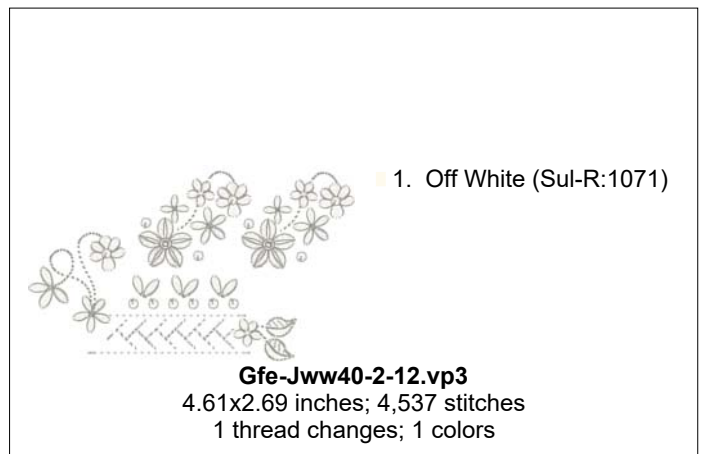
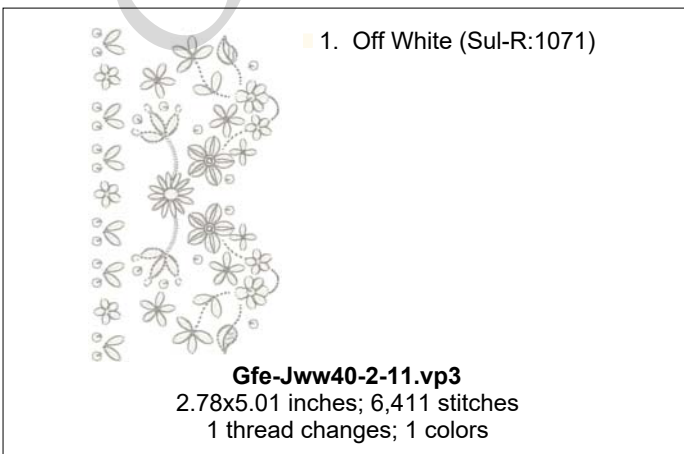
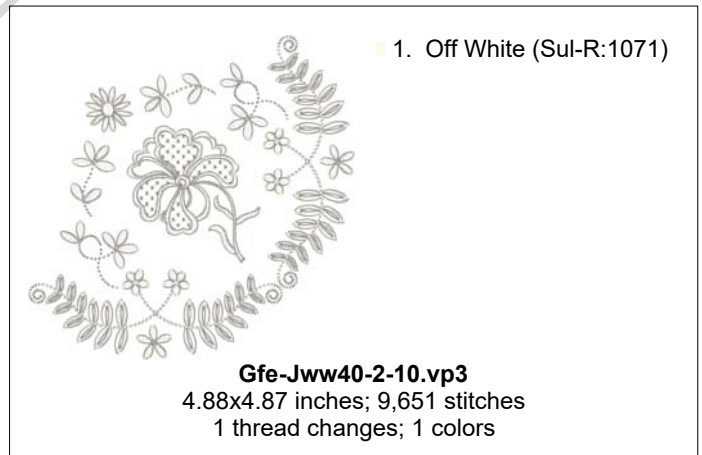
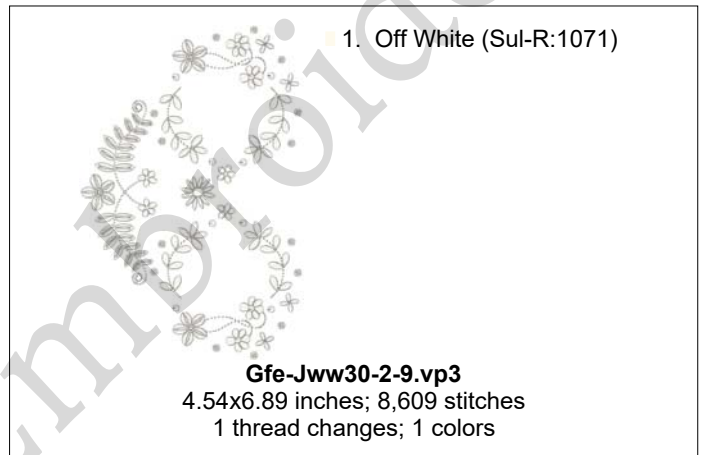
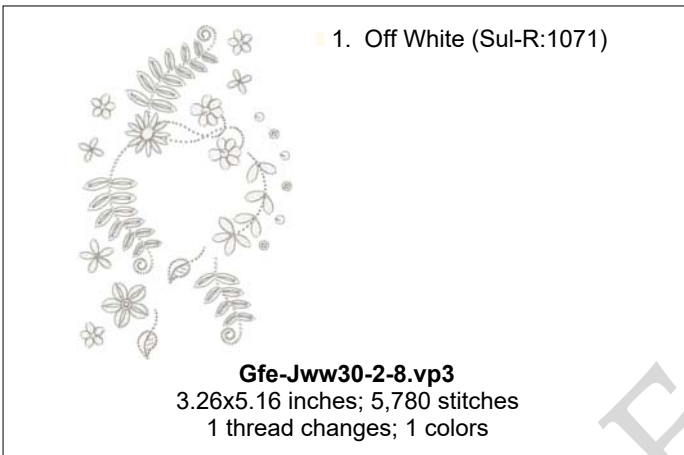
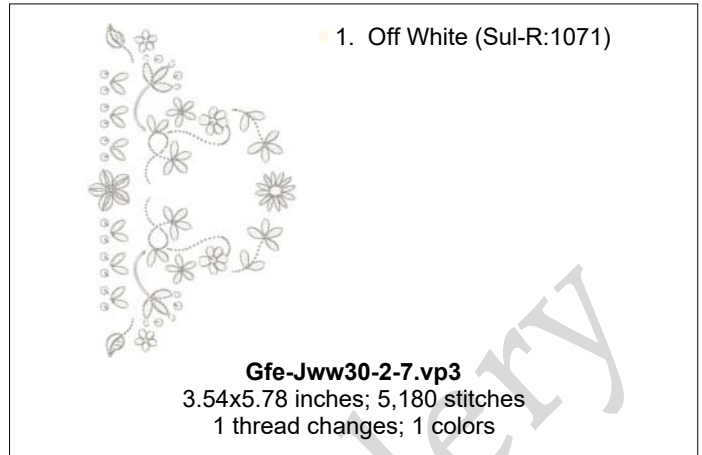

## Jane's White Work 2

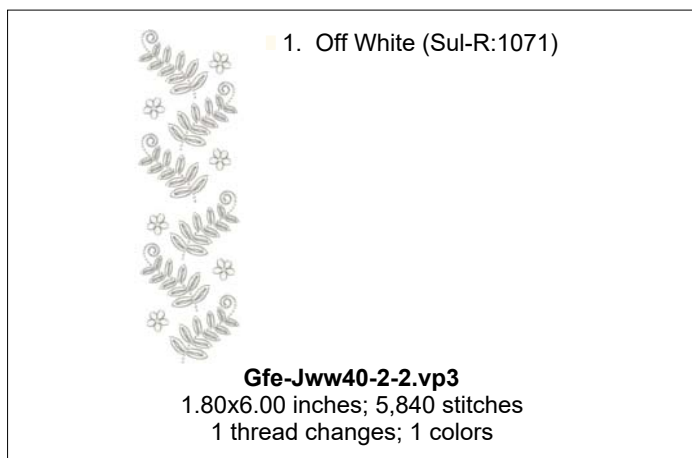
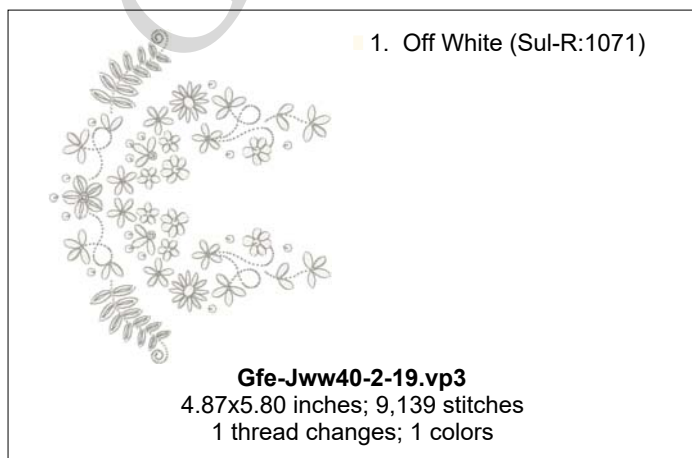
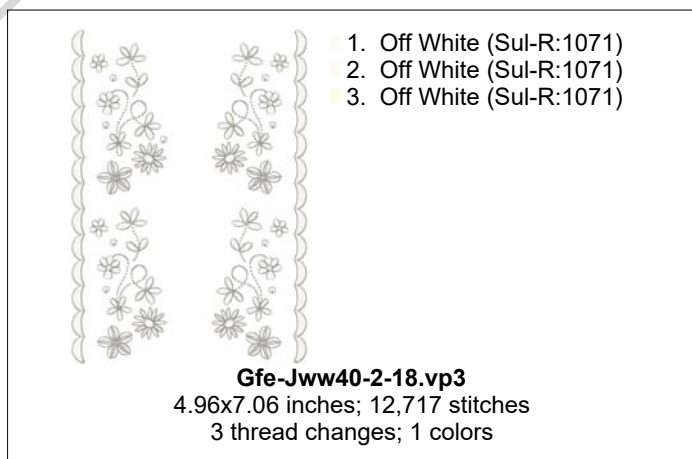
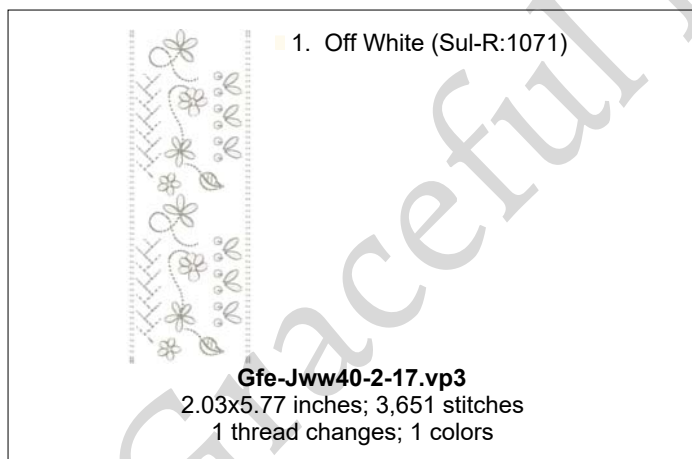
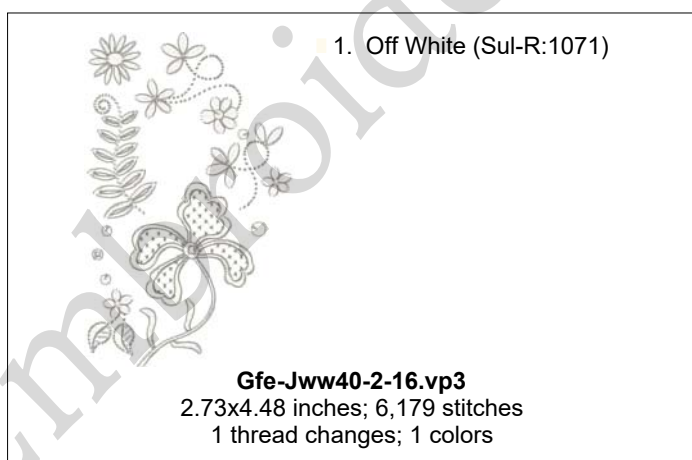
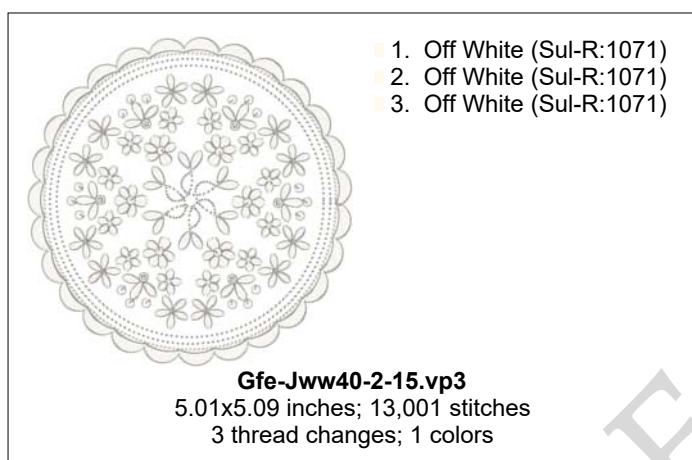
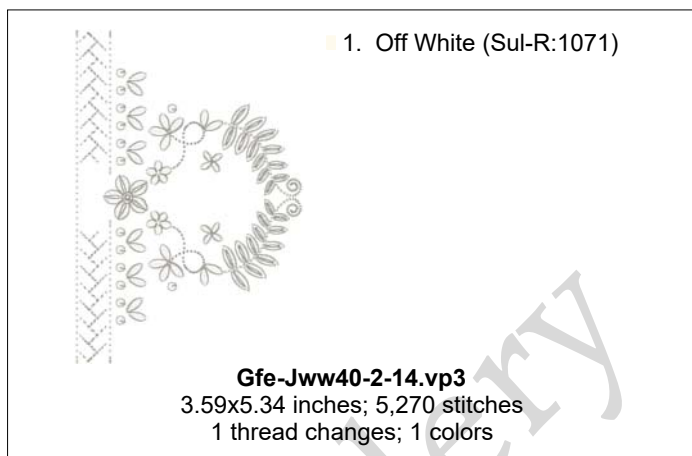
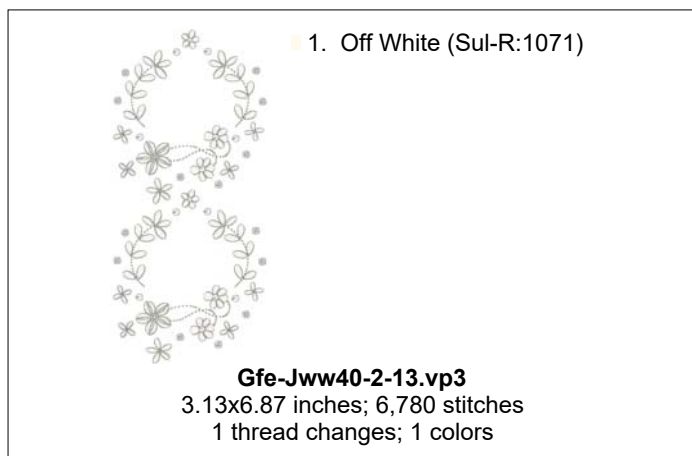



## Jane's White Work 2

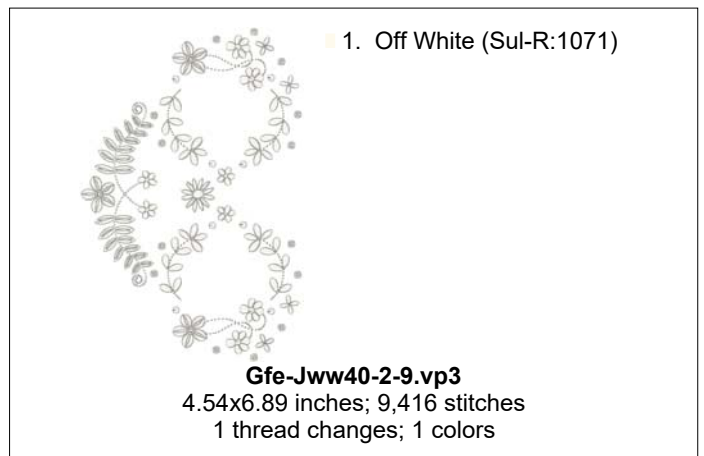
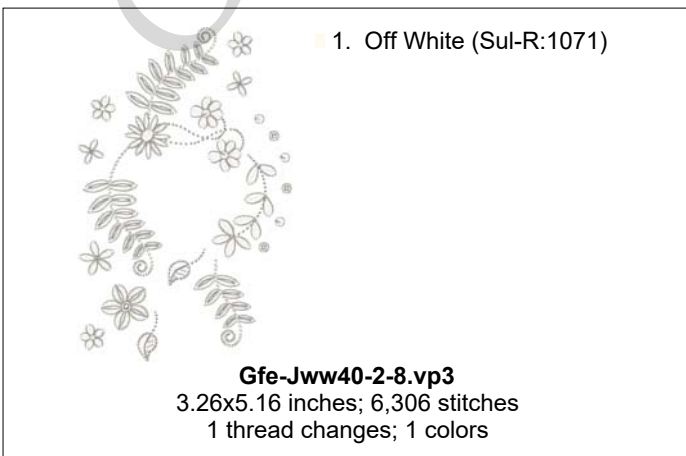
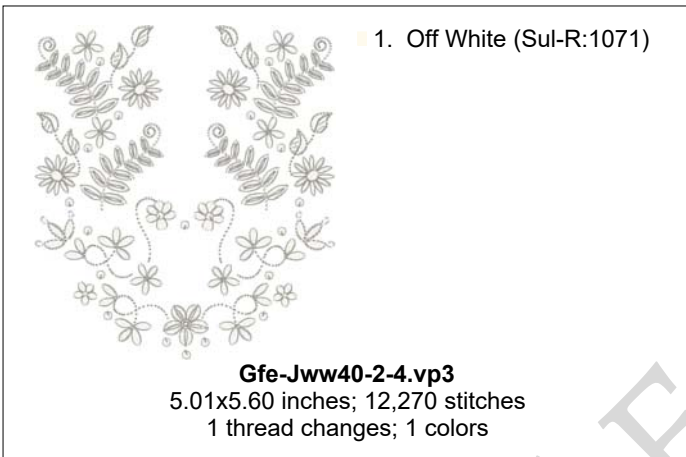
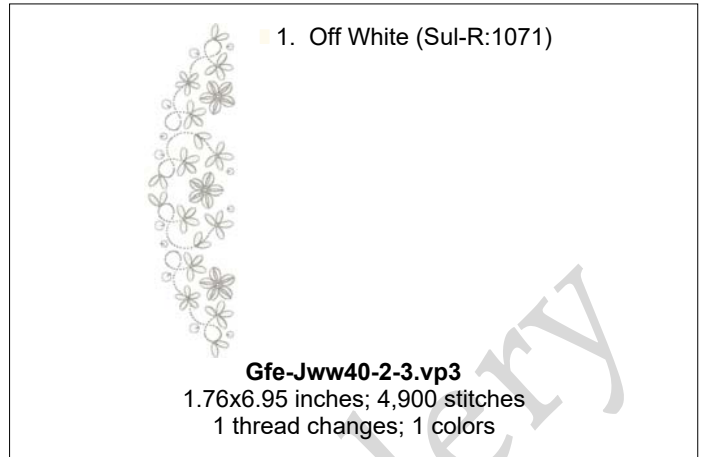
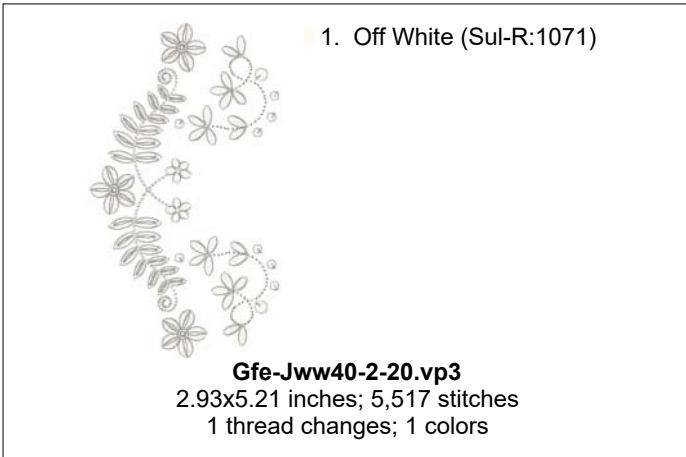

## Jane's White Work 2

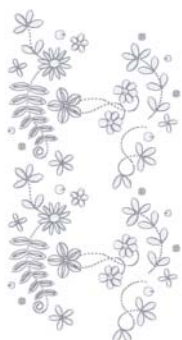

■ 1. Mad-P:1802

**Gfe-Jww60-2-1.vp3**

3.56x6.96 inches; 10,065 stitches  
1 thread changes; 1 colors



■ 1. Mad-P:1802

**Gfe-Jww60-2-10.vp3**

4.88x4.87 inches; 10,087 stitches  
1 thread changes; 1 colors



■ 1. Mad-P:1802

**Gfe-Jww60-2-11.vp3**

2.78x5.01 inches; 6,750 stitches  
1 thread changes; 1 colors



■ 1. Mad-P:1802

**Gfe-Jww60-2-12.vp3**

4.61x2.69 inches; 4,763 stitches  
1 thread changes; 1 colors



■ 1. Mad-P:1802

**Gfe-Jww60-2-13.vp3**

3.13x6.87 inches; 7,158 stitches  
1 thread changes; 1 colors



■ 1. Mad-P:1802

**Gfe-Jww60-2-14.vp3**

3.59x5.34 inches; 5,456 stitches  
1 thread changes; 1 colors



■ 1. Mad-P:1802  
■ 2. Mad-P:1802  
■ 3. Off White (Sul-R:1071)

**Gfe-Jww60-2-15.vp3**

5.01x5.09 inches; 13,631 stitches  
3 thread changes; 2 colors



■ 1. Mad-P:1802

**Gfe-Jww60-2-16.vp3**

2.73x4.48 inches; 6,495 stitches  
1 thread changes; 1 colors

## Jane's White Work 2

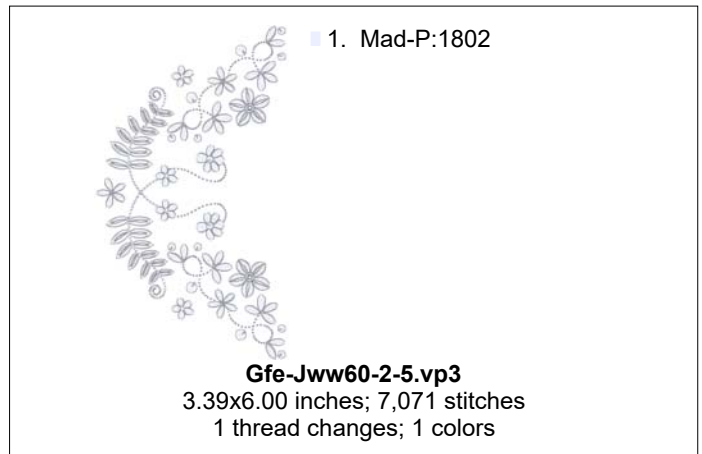
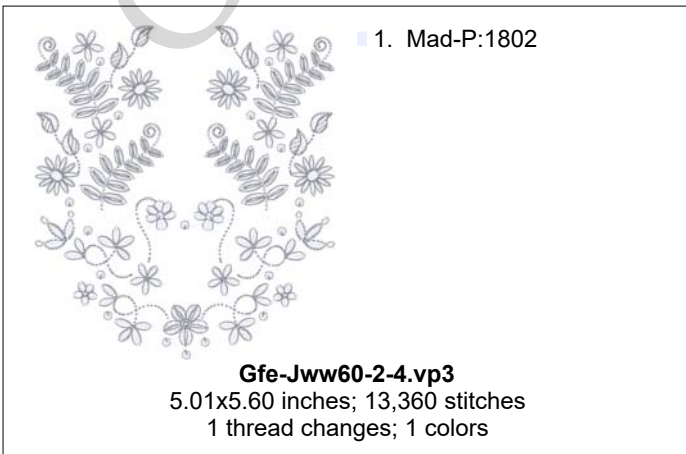
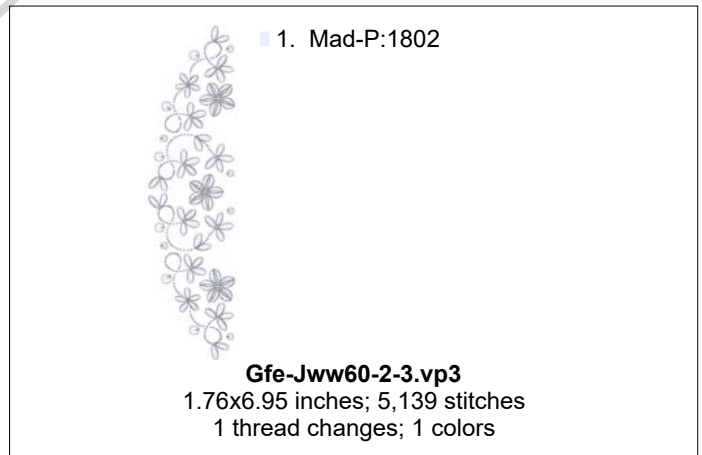
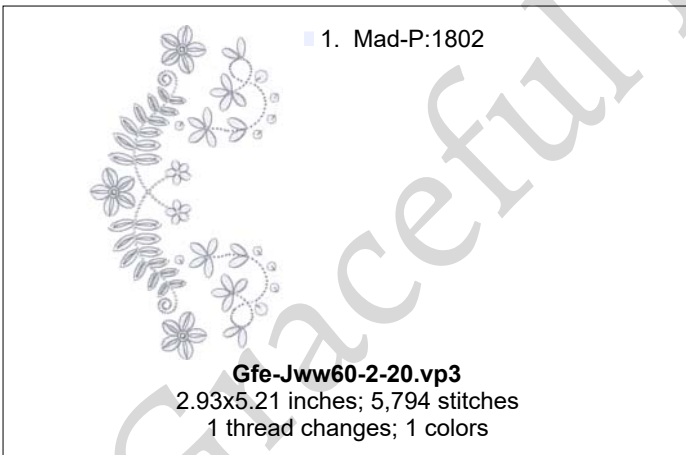
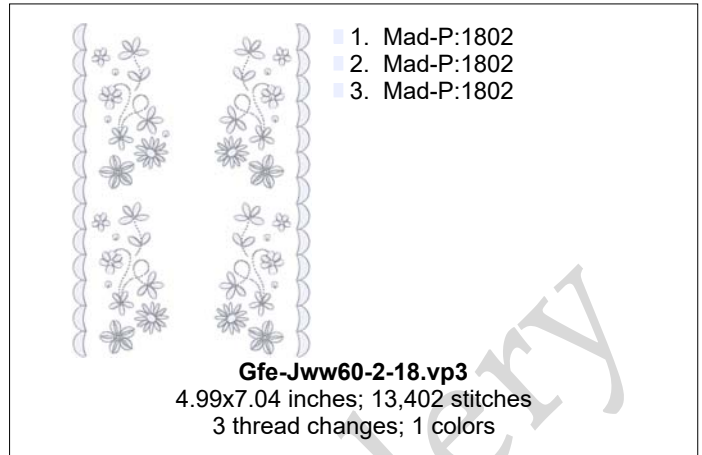

## Jane's White Work 2

Printed 03/02/2018

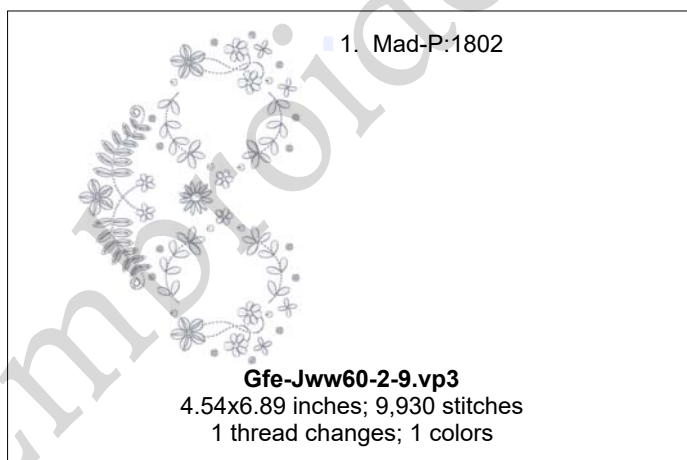
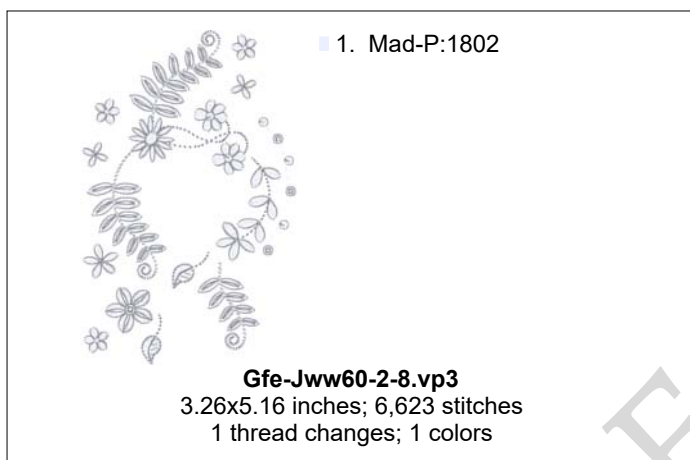
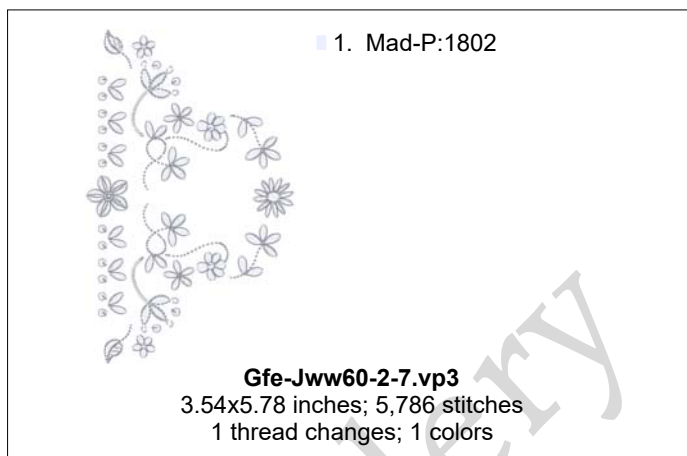
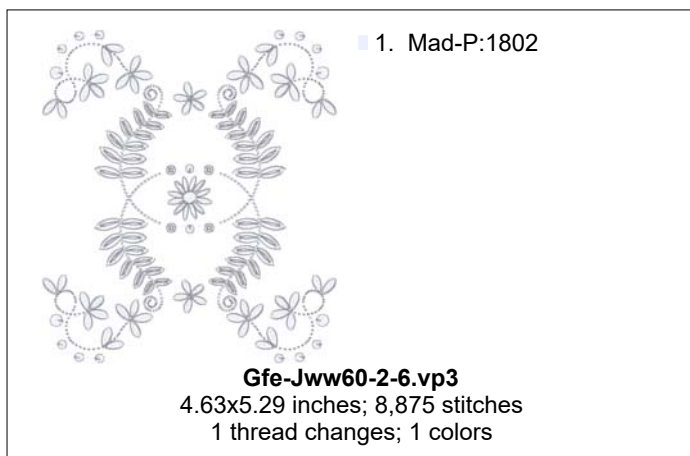

© Graceful Embroidery February 2018

## Jane's White Work 3



■ 1. Off White (Sul-R:1071)

**Gfe-Jww30-3-1.vp3**

2.84x7.83 inches; 8,886 stitches  
1 thread changes; 1 colors



■ 1. Off White (Sul-R:1071)  
■ 2. Off White (Sul-R:1071)  
■ 3. Off White (Sul-R:1071)

**Gfe-Jww30-3-10.vp3**

5.70x9.22 inches; 20,285 stitches  
3 thread changes; 1 colors



■ 1. Off White (Sul-R:1071)

**Gfe-Jww30-3-11.vp3**

5.78x5.93 inches; 14,254 stitches  
1 thread changes; 1 colors



■ 1. Off White (Sul-R:1071)

**Gfe-Jww30-3-12.vp3**

5.73x9.11 inches; 19,764 stitches  
1 thread changes; 1 colors



■ 1. Off White (Sul-R:1071)

**Gfe-Jww30-3-2.vp3**

3.99x8.59 inches; 9,681 stitches  
1 thread changes; 1 colors



■ 1. Off White (Sul-R:1071)

**Gfe-Jww30-3-3.vp3**

3.01x9.00 inches; 8,266 stitches  
1 thread changes; 1 colors



■ 1. Off White (Sul-R:1071)

**Gfe-Jww30-3-4.vp3**

5.32x8.96 inches; 11,726 stitches  
1 thread changes; 1 colors



■ 1. Off White (Sul-R:1071)

**Gfe-Jww30-3-5.vp3**

3.61x9.38 inches; 14,435 stitches  
1 thread changes; 1 colors

## Jane's White Work 3



■ 1. Off White (Sul-R:1071)

**Gfe-Jww30-3-6.vp3**

3.33x8.63 inches; 8,567 stitches  
1 thread changes; 1 colors



■ 1. Off White (Sul-R:1071)

**Gfe-Jww30-3-7.vp3**

5.58x8.84 inches; 20,825 stitches  
1 thread changes; 1 colors



■ 1. Off White (Sul-R:1071)

**Gfe-Jww30-3-8.vp3**

4.11x8.91 inches; 12,465 stitches  
1 thread changes; 1 colors



■ 1. Off White (Sul-R:1071)

**Gfe-Jww30-3-9.vp3**

5.77x8.35 inches; 20,641 stitches  
1 thread changes; 1 colors



■ 1. Off White (Sul-R:1071)

**Gfe-Jww40-3-1.vp3**

2.84x7.83 inches; 9,531 stitches  
1 thread changes; 1 colors



■ 1. Off White (Sul-R:1071)

■ 2. Off White (Sul-R:1071)

■ 3. Off White (Sul-R:1071)

**Gfe-Jww40-3-10.vp3**

5.70x9.22 inches; 21,767 stitches  
3 thread changes; 1 colors



■ 1. Off White (Sul-R:1071)

**Gfe-Jww40-3-11.vp3**

5.78x5.93 inches; 15,907 stitches  
1 thread changes; 1 colors



■ 1. Off White (Sul-R:1071)

**Gfe-Jww40-3-12.vp3**

5.72x9.11 inches; 21,732 stitches  
1 thread changes; 1 colors

## Jane's White Work 3



■ 1. Off White (Sul-R:1071)

**Gfe-Jww40-3-2.vp3**

3.99x8.59 inches; 10,352 stitches  
1 thread changes; 1 colors



■ 1. Off White (Sul-R:1071)

**Gfe-Jww40-3-3.vp3**

3.00x9.00 inches; 8,876 stitches  
1 thread changes; 1 colors



■ 1. Off White (Sul-R:1071)

**Gfe-Jww40-3-4.vp3**

5.32x8.96 inches; 12,732 stitches  
1 thread changes; 1 colors



● 1. Off White (Sul-R:1071)

**Gfe-Jww40-3-5.vp3**

3.61x9.38 inches; 15,859 stitches  
1 thread changes; 1 colors



■ 1. Off White (Sul-R:1071)

**Gfe-Jww40-3-6.vp3**

3.33x8.63 inches; 9,269 stitches  
1 thread changes; 1 colors



■ 1. Off White (Sul-R:1071)

**Gfe-Jww40-3-7.vp3**

5.58x8.84 inches; 23,115 stitches  
1 thread changes; 1 colors



■ 1. Off White (Sul-R:1071)

**Gfe-Jww40-3-8.vp3**

4.11x8.91 inches; 13,669 stitches  
1 thread changes; 1 colors



■ 1. Off White (Sul-R:1071)

**Gfe-Jww40-3-9.vp3**

5.77x8.35 inches; 22,501 stitches  
1 thread changes; 1 colors

## Jane's White Work 3



■ 1. Mad-P:1802

**Gfe-Jww60-3-1.vp3**

2.84x7.83 inches; 10,022 stitches  
1 thread changes; 1 colors



■ 1. Mad-P:1802  
■ 2. Mad-P:1802  
■ 3. Mad-P:1802

**Gfe-Jww60-3-10.vp3**

5.70x9.22 inches; 22,576 stitches  
3 thread changes; 1 colors



■ 1. Mad-P:1802

**Gfe-Jww60-3-11.vp3**

5.78x5.93 inches; 16,626 stitches  
1 thread changes; 1 colors



■ 1. Mad-P:1802

**Gfe-Jww60-3-12.vp3**

5.72x9.11 inches; 22,668 stitches  
1 thread changes; 1 colors



■ 1. Mad-P:1802

**Gfe-Jww60-3-2.vp3**

3.99x8.59 inches; 10,834 stitches  
1 thread changes; 1 colors



■ 1. Mad-P:1802

**Gfe-Jww60-3-3.vp3**

3.00x9.00 inches; 9,329 stitches  
1 thread changes; 1 colors



■ 1. Mad-P:1802

**Gfe-Jww60-3-4.vp3**

5.32x8.96 inches; 13,391 stitches  
1 thread changes; 1 colors



■ 1. Mad-P:1802

**Gfe-Jww60-3-5.vp3**

3.61x9.38 inches; 16,690 stitches  
1 thread changes; 1 colors



### Jane's White Work 3

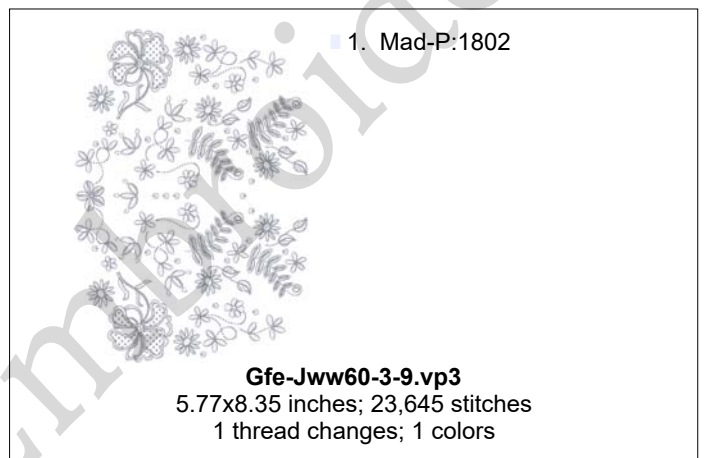
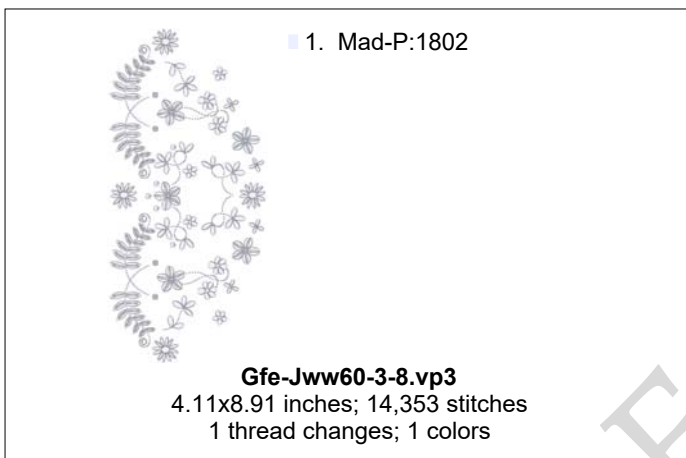
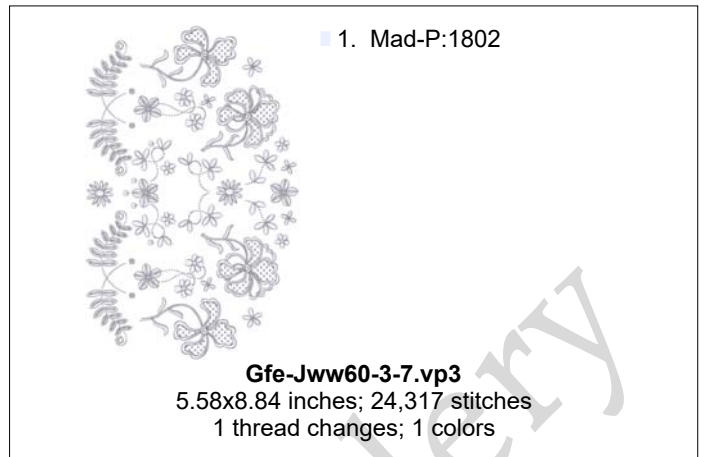
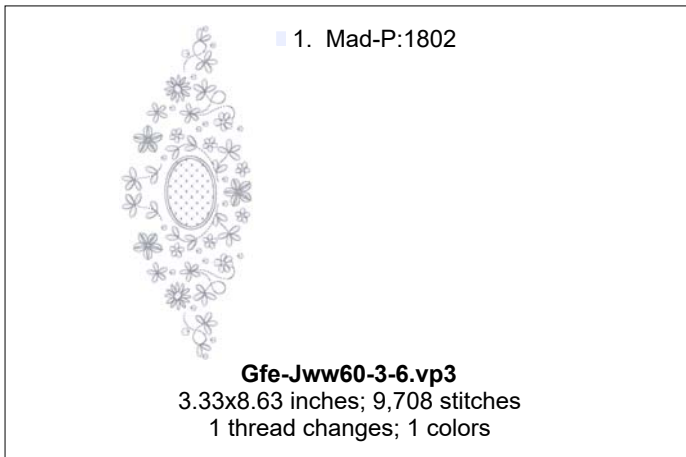

## Jane's White Work 4

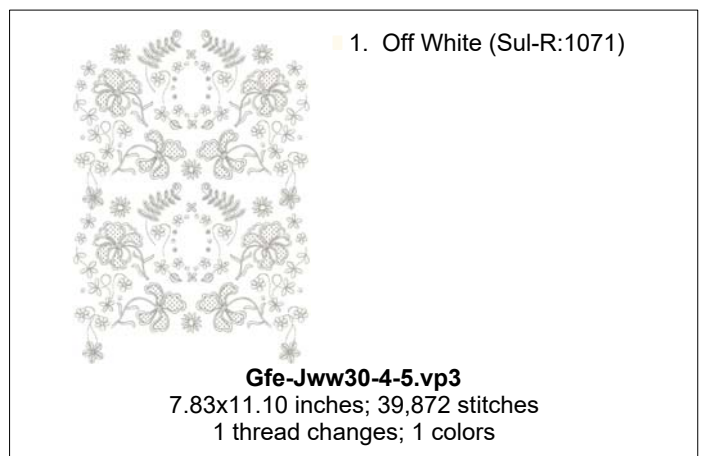
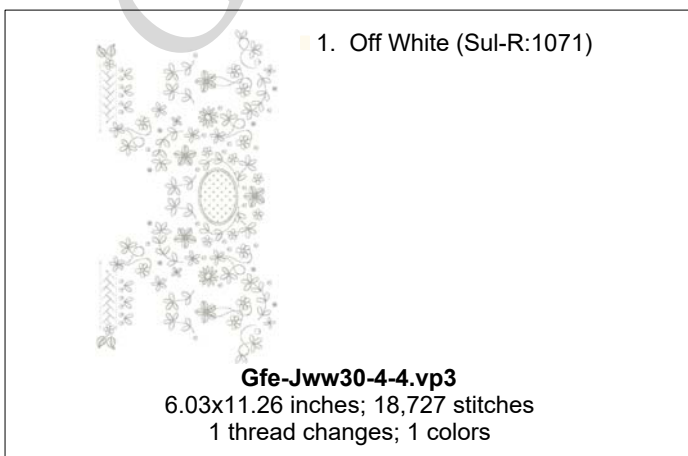
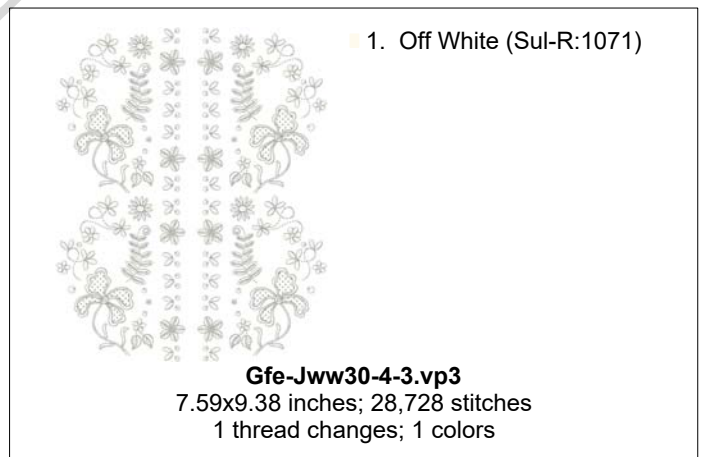
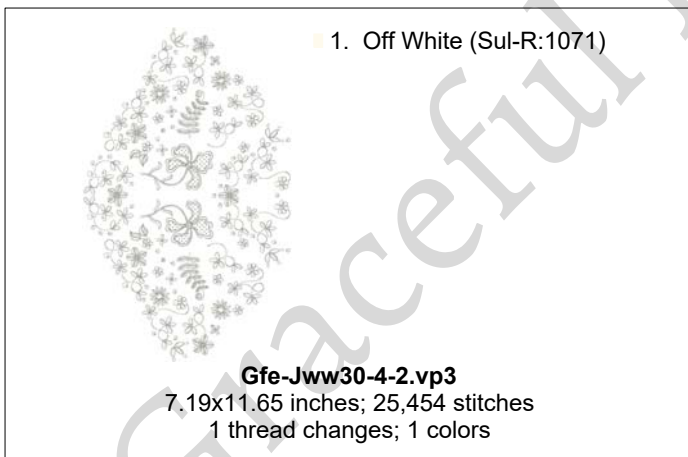
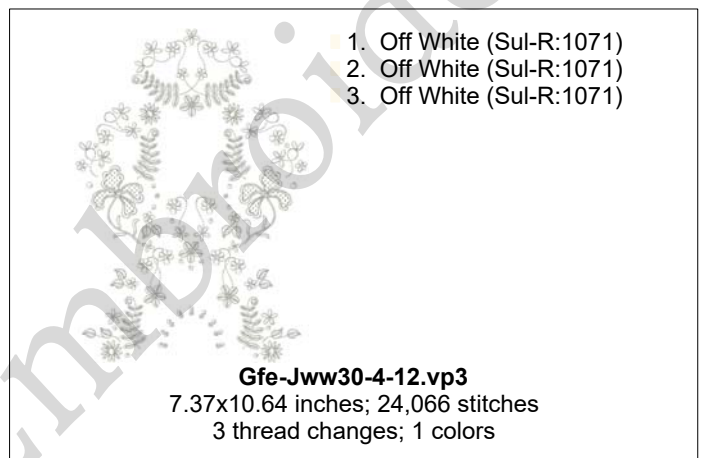
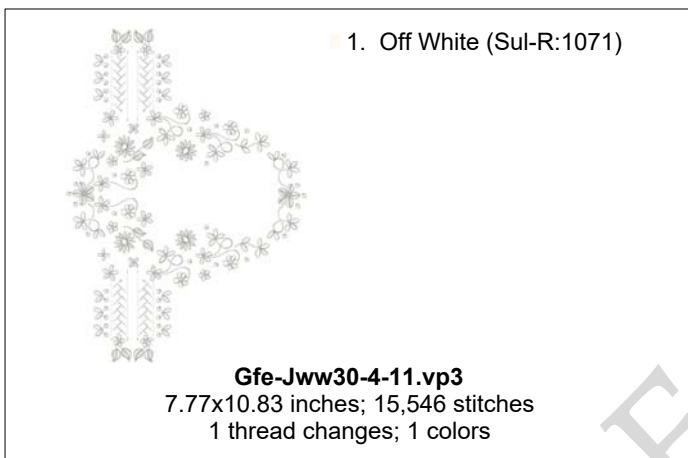
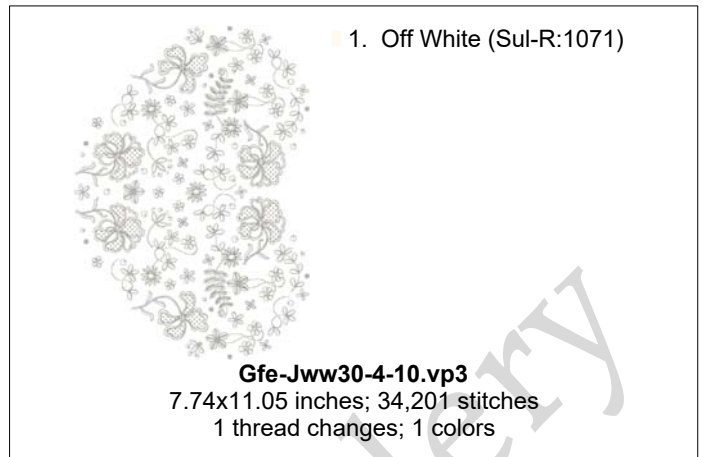
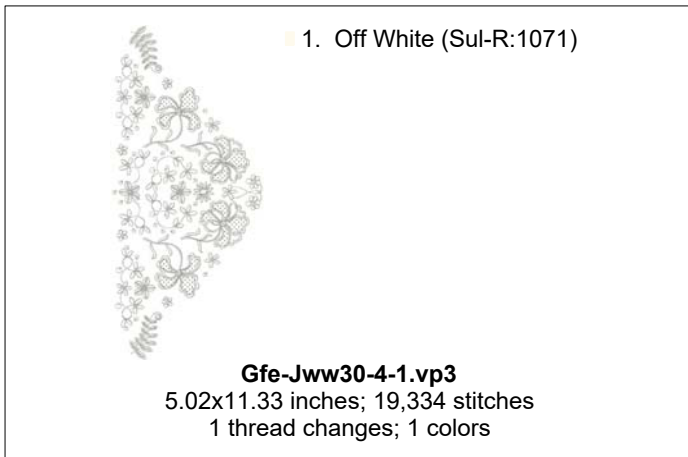

## Jane's White Work 4

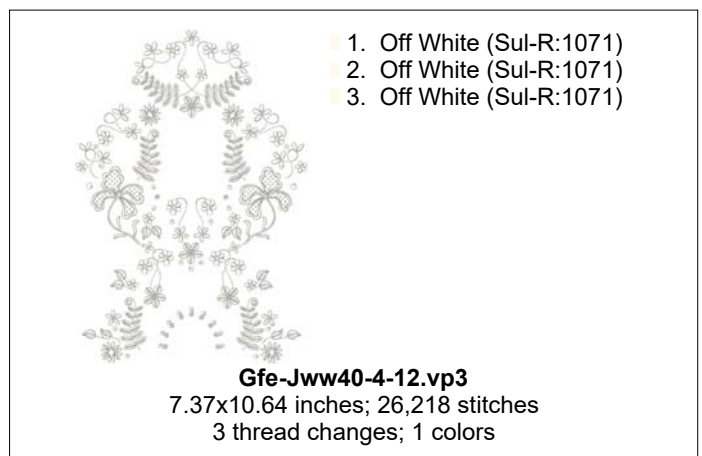
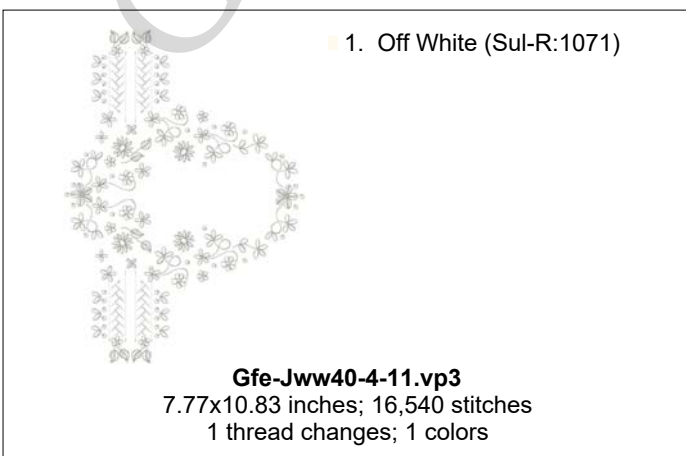
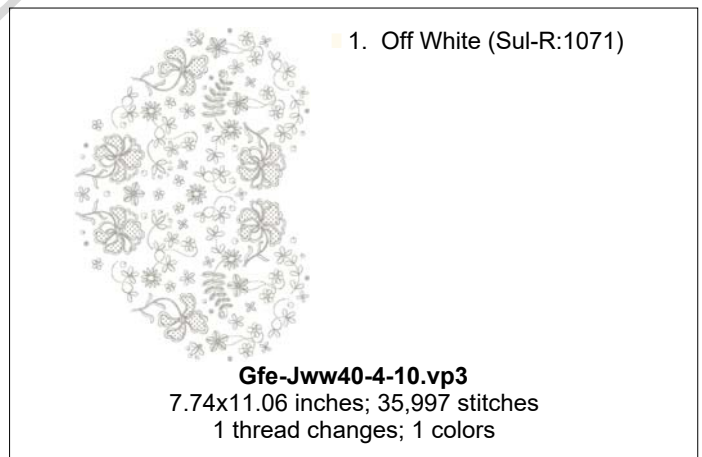
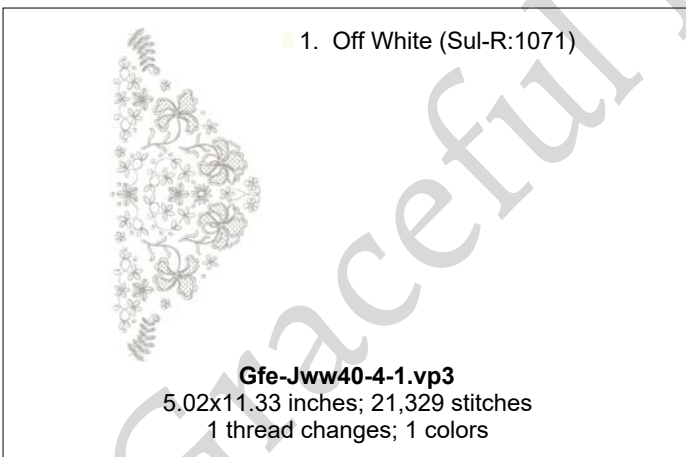
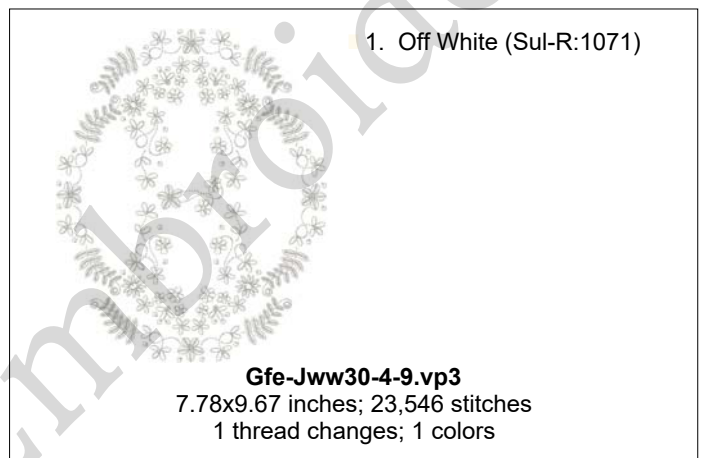
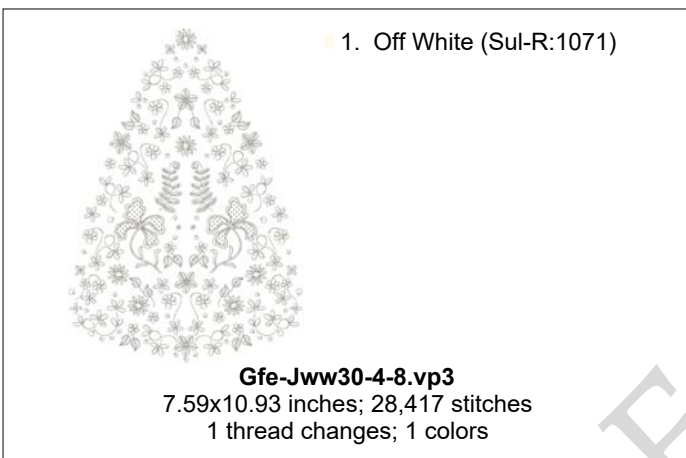
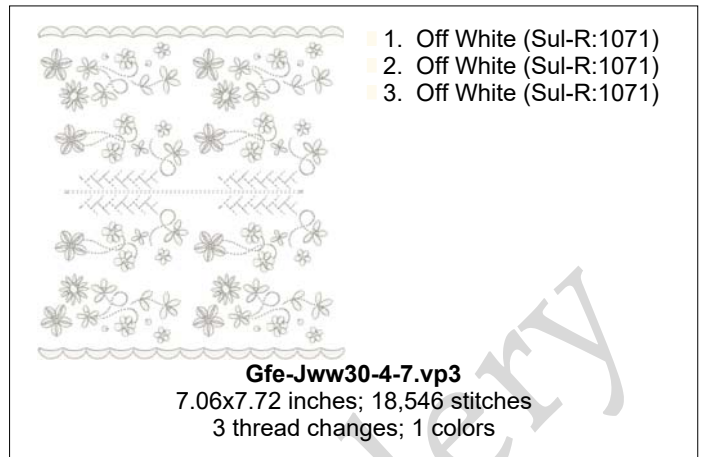
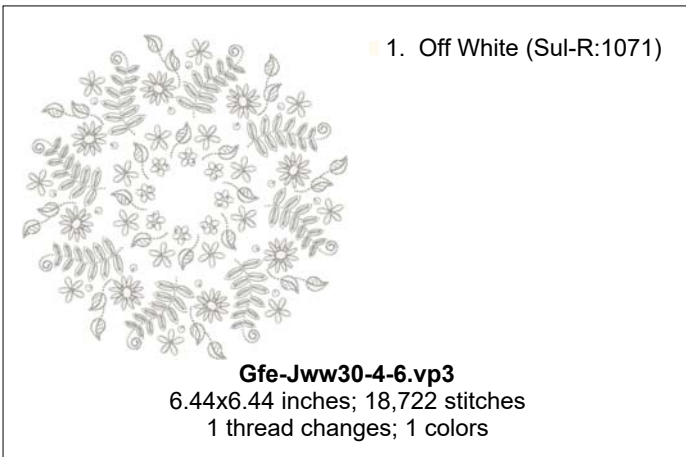

## Jane's White Work 4

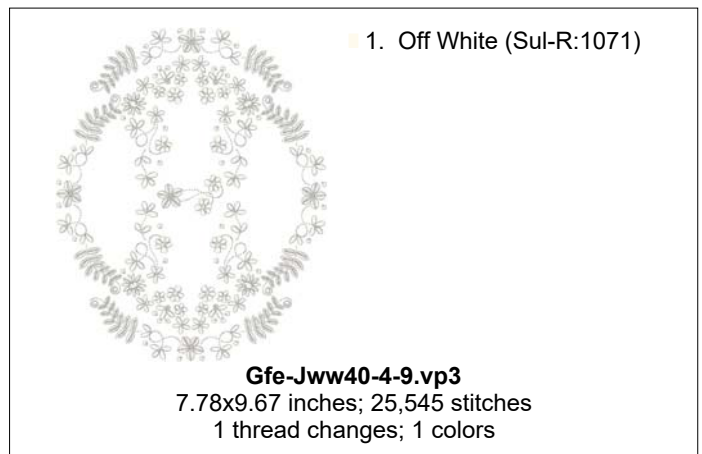
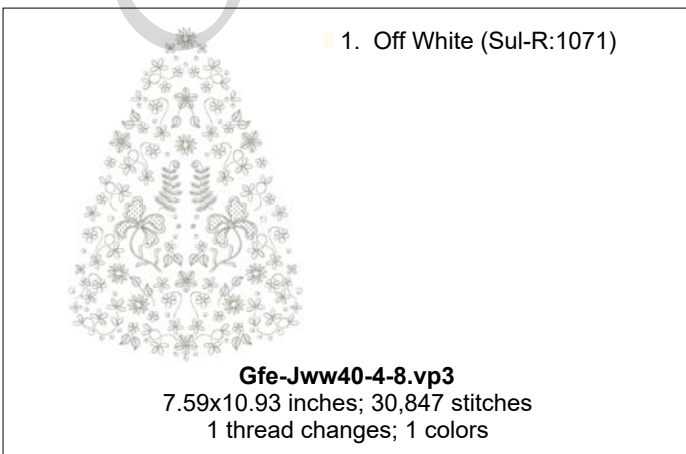
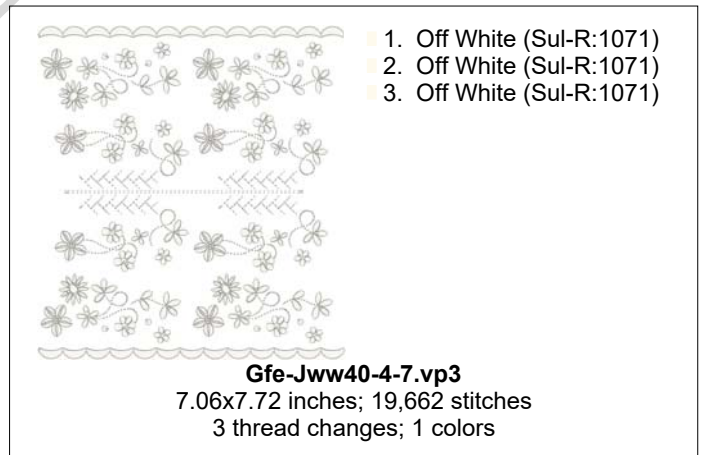
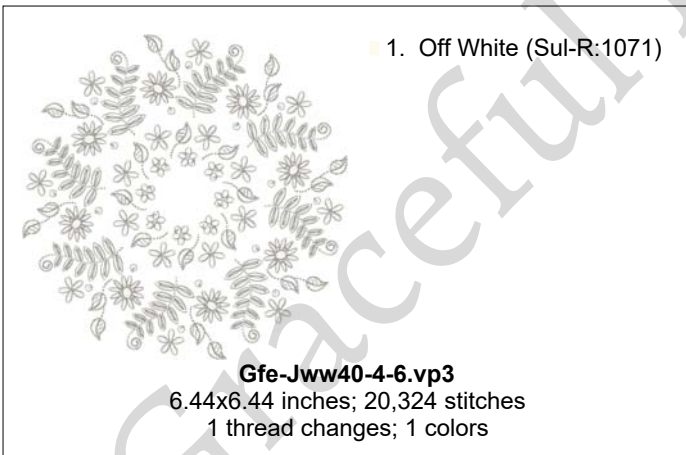
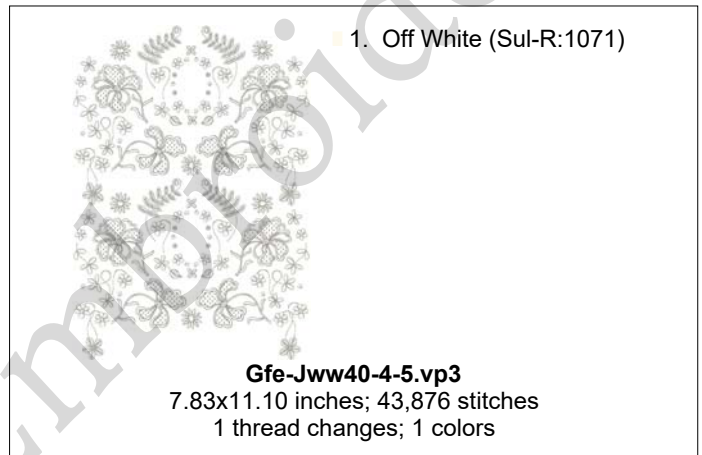
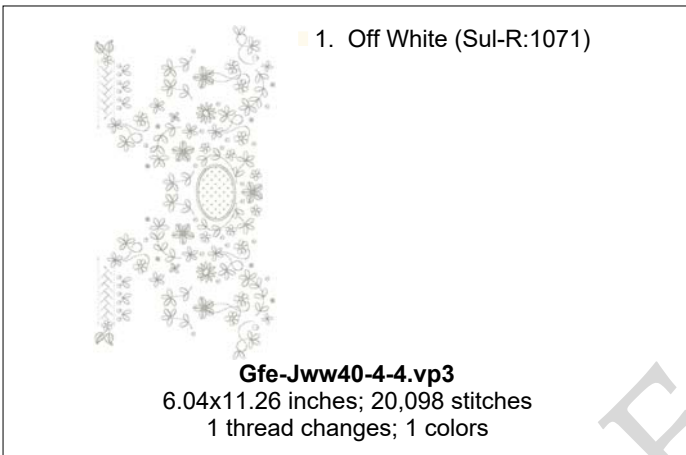
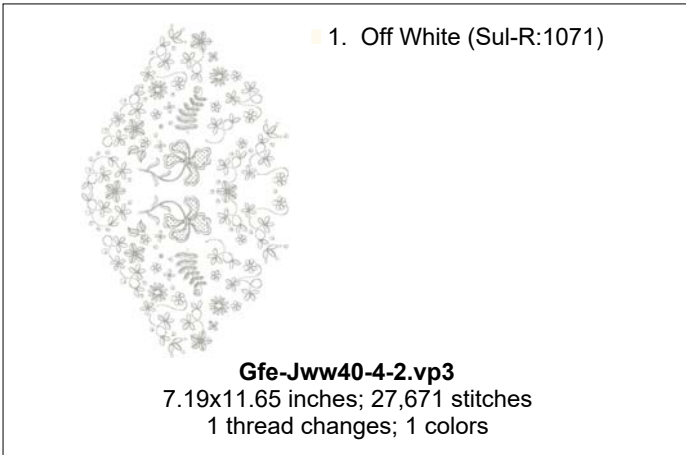

## Jane's White Work 4



■ 1. Mad-P:1802

**Gfe-Jww60-4-1.vp3**  
5.02x11.33 inches; 22,430 stitches  
1 thread changes; 1 colors



■ 1. Mad-P:1802

**Gfe-Jww60-4-10.vp3**  
7.74x11.06 inches; 37,633 stitches  
1 thread changes; 1 colors



■ 1. Mad-P:1802

**Gfe-Jww60-4-11.vp3**  
7.77x10.83 inches; 17,239 stitches  
1 thread changes; 1 colors



■ 1. Mad-P:1802  
■ 2. Mad-P:1802  
■ 3. Mad-P:1802

**Gfe-Jww60-4-12.vp3**  
7.37x10.64 inches; 27,636 stitches  
3 thread changes; 1 colors



■ 1. Mad-P:1802

**Gfe-Jww60-4-2.vp3**  
7.19x11.65 inches; 29,063 stitches  
1 thread changes; 1 colors



■ 1. Mad-P:1802

**Gfe-Jww60-4-3.vp3**  
7.59x9.38 inches; 33,277 stitches  
1 thread changes; 1 colors



■ 1. Mad-P:1802

**Gfe-Jww60-4-4.vp3**  
6.03x11.26 inches; 21,083 stitches  
1 thread changes; 1 colors



■ 1. Mad-P:1802

**Gfe-Jww60-4-5.vp3**  
7.83x11.10 inches; 46,260 stitches  
1 thread changes; 1 colors

## Jane's White Work 4

