

- 1. Temple Gold (Sul-R:1159)
- 2. Tawny Tan (Sul-R:1055)
- 3. Temple Gold (Sul-R:1159)
- 4. (Sul-R:1245)
- 5. Tawny Tan (Sul-R:1055)
- 6. (Sul-R:1245)
- 7. Temple Gold (Sul-R:1159)
- 8. Tawny Tan (Sul-R:1055)
- 9. (Sul-R:1245)

**Gfe-Ccr-1-1a.vp3**  
7.53x11.19 inches; 17,971 stitches  
9 thread changes; 3 colors

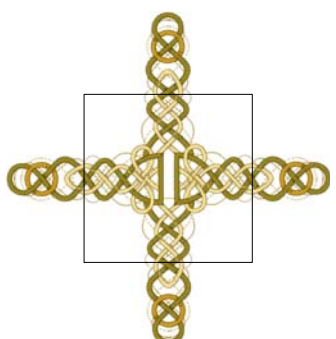

- 1. Temple Gold (Sul-R:1159)
- 2. Tawny Tan (Sul-R:1055)
- 3. Temple Gold (Sul-R:1159)
- 4. (Sul-R:1245)
- 5. Tawny Tan (Sul-R:1055)
- 6. (Sul-R:1245)
- 7. Tawny Tan (Sul-R:1055)
- 8. Temple Gold (Sul-R:1159)
- 9. (Sul-R:1245)

**Gfe-Ccr-1-1b.vp3**  
7.53x7.78 inches; 14,073 stitches  
9 thread changes; 3 colors

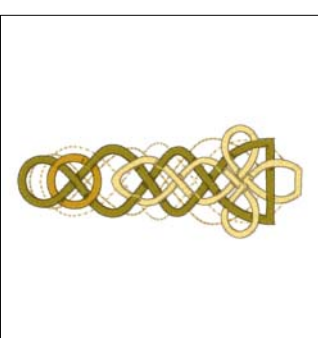

- 1. Tawny Tan (Sul-R:1055)
- 2. Temple Gold (Sul-R:1159)
- 3. Tawny Tan (Sul-R:1055)
- 4. (Sul-R:1245)
- 5. Temple Gold (Sul-R:1159)
- 6. (Sul-R:1245)
- 7. Tawny Tan (Sul-R:1055)
- 8. Temple Gold (Sul-R:1159)

**Gfe-Ccr-1-1c.vp3**  
4.04x1.61 inches; 4,239 stitches  
8 thread changes; 3 colors

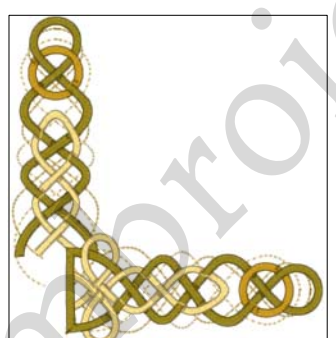

- 1. Temple Gold (Sul-R:1159)
- 2. Tawny Tan (Sul-R:1055)
- 3. Temple Gold (Sul-R:1159)
- 4. (Sul-R:1245)
- 5. Tawny Tan (Sul-R:1055)
- 6. (Sul-R:1245)
- 7. Tawny Tan (Sul-R:1055)
- 8. Temple Gold (Sul-R:1159)
- 9. (Sul-R:1245)

**Gfe-Ccr-1-1d.vp3**  
4.40x4.69 inches; 7,062 stitches  
9 thread changes; 3 colors

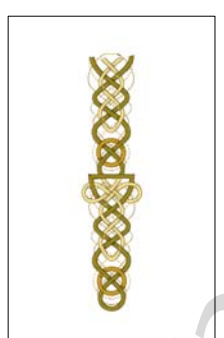

- 1. Temple Gold (Sul-R:1159)
- 2. Tawny Tan (Sul-R:1055)
- 3. Temple Gold (Sul-R:1159)
- 4. (Sul-R:1245)
- 5. Tawny Tan (Sul-R:1055)
- 6. (Sul-R:1245)
- 7. Temple Gold (Sul-R:1159)
- 8. Tawny Tan (Sul-R:1055)
- 9. (Sul-R:1245)

**Gfe-Ccr-1-1e.vp3**  
1.61x6.84 inches; 6,894 stitches  
9 thread changes; 3 colors

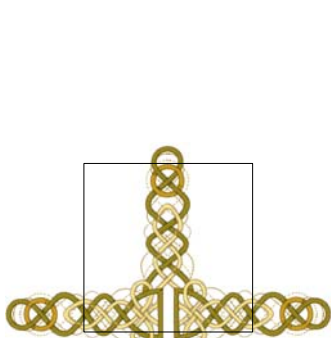

- 1. Temple Gold (Sul-R:1159)
- 2. Tawny Tan (Sul-R:1055)
- 3. Temple Gold (Sul-R:1159)
- 4. (Sul-R:1245)
- 5. Tawny Tan (Sul-R:1055)
- 6. (Sul-R:1245)
- 7. Tawny Tan (Sul-R:1055)
- 8. Temple Gold (Sul-R:1159)
- 9. (Sul-R:1245)

**Gfe-Ccr-1-1f.vp3**  
7.53x4.71 inches; 11,019 stitches  
9 thread changes; 3 colors

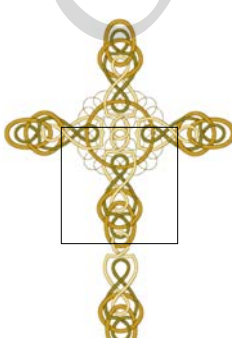

- 1. Temple Gold (Sul-R:1159)
- 2. (Sul-R:1245)
- 3. Tawny Tan (Sul-R:1055)
- 4. (Sul-R:1245)
- 5. Temple Gold (Sul-R:1159)
- 6. (Sul-R:1245)
- 7. Temple Gold (Sul-R:1159)
- 8. (Sul-R:1245)
- 9. Tawny Tan (Sul-R:1055)
- 10. Temple Gold (Sul-R:1159)

**Gfe-Ccr-1-2a.vp3**  
7.73x11.24 inches; 19,764 stitches  
10 thread changes; 3 colors

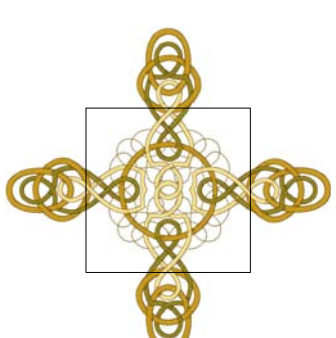

- 1. Temple Gold (Sul-R:1159)
- 2. (Sul-R:1245)
- 3. Tawny Tan (Sul-R:1055)
- 4. (Sul-R:1245)
- 5. Temple Gold (Sul-R:1159)
- 6. (Sul-R:1245)
- 7. Temple Gold (Sul-R:1159)
- 8. (Sul-R:1245)
- 9. Tawny Tan (Sul-R:1055)
- 10. Temple Gold (Sul-R:1159)

**Gfe-Ccr-1-2b.vp3**  
7.73x7.73 inches; 15,980 stitches  
10 thread changes; 3 colors



- 1. Tawny Tan (Sul-R:1055)
- 2. (Sul-R:1245)
- 3. Temple Gold (Sul-R:1159)
- 4. (Sul-R:1245)
- 5. Temple Gold (Sul-R:1159)
- 6. (Sul-R:1245)
- 7. Tawny Tan (Sul-R:1055)

**Gfe-Ccr-1-2c.vp3**  
1.53x4.10 inches; 3,592 stitches  
7 thread changes; 3 colors

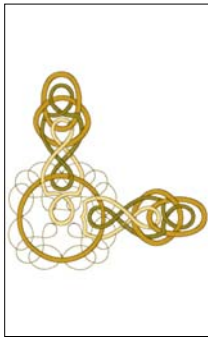

- 1. Temple Gold (Sul-R:1159)
- 2. (Sul-R:1245)
- 3. Tawny Tan (Sul-R:1055)
- 4. (Sul-R:1245)
- 5. Temple Gold (Sul-R:1159)
- 6. (Sul-R:1245)
- 7. Temple Gold (Sul-R:1159)
- 8. (Sul-R:1245)
- 9. Tawny Tan (Sul-R:1055)
- 10. Temple Gold (Sul-R:1159)

**Gfe-Ccr-1-2d.vp3**  
5.28x5.28 inches; 8,633 stitches  
10 thread changes; 3 colors

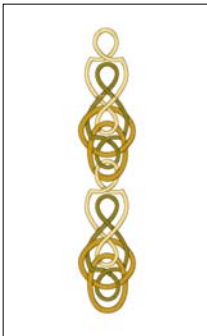

- 1. Tawny Tan (Sul-R:1055)
- 2. (Sul-R:1245)
- 3. Temple Gold (Sul-R:1159)
- 4. (Sul-R:1245)
- 5. Temple Gold (Sul-R:1159)
- 6. (Sul-R:1245)
- 7. Tawny Tan (Sul-R:1055)

**Gfe-Ccr-1-2e.vp3**  
1.53x7.60 inches; 7,425 stitches  
7 thread changes; 3 colors

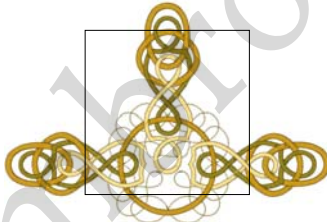

- 1. Temple Gold (Sul-R:1159)
- 2. (Sul-R:1245)
- 3. Tawny Tan (Sul-R:1055)
- 4. (Sul-R:1245)
- 5. Temple Gold (Sul-R:1159)
- 6. (Sul-R:1245)
- 7. Temple Gold (Sul-R:1159)
- 8. (Sul-R:1245)
- 9. Tawny Tan (Sul-R:1055)
- 10. Temple Gold (Sul-R:1159)

**Gfe-Ccr-1-2f.vp3**  
7.74x5.28 inches; 12,043 stitches  
10 thread changes; 3 colors

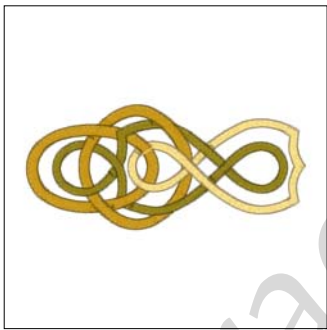

- 1. Tawny Tan (Sul-R:1055)
- 2. (Sul-R:1245)
- 3. Temple Gold (Sul-R:1159)
- 4. (Sul-R:1245)
- 5. Temple Gold (Sul-R:1159)
- 6. (Sul-R:1245)
- 7. Tawny Tan (Sul-R:1055)

**Gfe-Ccr-1-2g.vp3**  
3.40x1.53 inches; 3,331 stitches  
7 thread changes; 3 colors

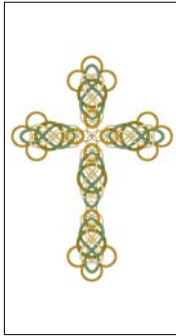

- 1. Temple Gold (Sul-R:1159)
- 2. Moss Green (Sul-R:630)
- 3. Temple Gold (Sul-R:1159)
- 4. Tawny Tan (Sul-R:1055)
- 5. Moss Green (Sul-R:630)
- 6. (Sul-R:1245)
- 7. Moss Green (Sul-R:630)
- 8. Temple Gold (Sul-R:1159)
- 9. Tawny Tan (Sul-R:1055)

**Gfe-Ccr-1-3a.vp3**  
6.85x9.61 inches; 19,694 stitches  
9 thread changes; 4 colors

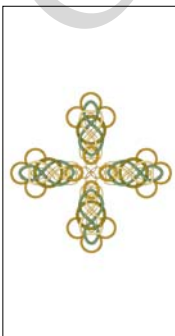

- 1. Temple Gold (Sul-R:1159)
- 2. (Sul-R:1245)
- 3. Temple Gold (Sul-R:1159)
- 4. Tawny Tan (Sul-R:1055)
- 5. Moss Green (Sul-R:630)
- 6. (Sul-R:1245)
- 7. Moss Green (Sul-R:630)
- 8. Temple Gold (Sul-R:1159)
- 9. Tawny Tan (Sul-R:1055)

**Gfe-Ccr-1-3b.vp3**  
6.85x6.84 inches; 16,402 stitches  
9 thread changes; 4 colors

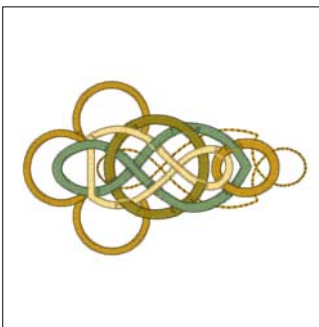

- 1. Temple Gold (Sul-R:1159)
- 2. (Sul-R:1245)
- 3. Temple Gold (Sul-R:1159)
- 4. Tawny Tan (Sul-R:1055)
- 5. Moss Green (Sul-R:630)
- 6. Tawny Tan (Sul-R:1055)
- 7. (Sul-R:1245)
- 8. Moss Green (Sul-R:630)
- 9. Temple Gold (Sul-R:1159)
- 10. Tawny Tan (Sul-R:1055)

**Gfe-Ccr-1-3c.vp3**  
3.42x2.12 inches; 4,093 stitches  
10 thread changes; 4 colors

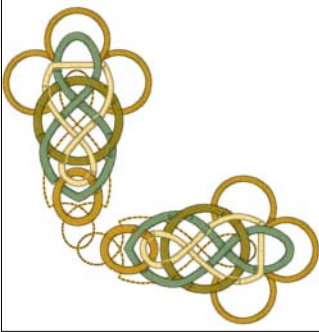

- 1. Temple Gold (Sul-R:1159)
- 2. (Sul-R:1245)
- 3. Temple Gold (Sul-R:1159)
- 4. Tawny Tan (Sul-R:1055)
- 5. Moss Green (Sul-R:630)
- 6. (Sul-R:1245)
- 7. Moss Green (Sul-R:630)
- 8. Temple Gold (Sul-R:1159)
- 9. Tawny Tan (Sul-R:1055)

**Gfe-Ccr-1-3d.vp3**  
4.49x4.50 inches; 8,308 stitches  
9 thread changes; 4 colors

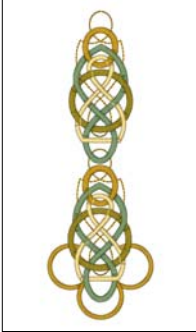

- 1. Temple Gold (Sul-R:1159)
- 2. (Sul-R:1245)
- 3. Temple Gold (Sul-R:1159)
- 4. Tawny Tan (Sul-R:1055)
- 5. Moss Green (Sul-R:630)
- 6. (Sul-R:1245)
- 7. Moss Green (Sul-R:630)
- 8. Temple Gold (Sul-R:1159)
- 9. Tawny Tan (Sul-R:1055)

**Gfe-Ccr-1-3e.vp3**  
2.12x6.20 inches; 7,416 stitches  
9 thread changes; 4 colors



- 1. Temple Gold (Sul-R:1159)
- 2. (Sul-R:1245)
- 3. Temple Gold (Sul-R:1159)
- 4. Tawny Tan (Sul-R:1055)
- 5. Moss Green (Sul-R:630)
- 6. (Sul-R:1245)
- 7. Moss Green (Sul-R:630)
- 8. Temple Gold (Sul-R:1159)
- 9. Tawny Tan (Sul-R:1055)

**Gfe-Ccr-1-3f.vp3**  
6.85x4.50 inches; 12,301 stitches  
9 thread changes; 4 colors

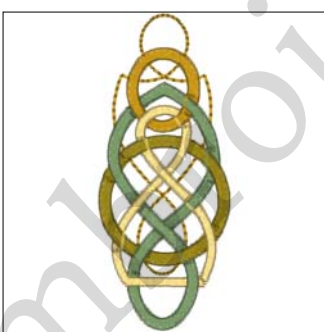

- 1. Temple Gold (Sul-R:1159)
- 2. (Sul-R:1245)
- 3. Temple Gold (Sul-R:1159)
- 4. Tawny Tan (Sul-R:1055)
- 5. Moss Green (Sul-R:630)
- 6. (Sul-R:1245)
- 7. Moss Green (Sul-R:630)
- 8. Temple Gold (Sul-R:1159)
- 9. Tawny Tan (Sul-R:1055)

**Gfe-Ccr-1-3g.vp3**  
1.28x3.07 inches; 3,296 stitches  
9 thread changes; 4 colors



- 1. (Sul-R:1245)
- 2. Tawny Tan (Sul-R:1055)
- 3. (Sul-R:1245)
- 4. (Sul-R:1244)

**Gfe-Ccr-1-4a.vp3**  
5.74x10.13 inches; 18,188 stitches  
4 thread changes; 3 colors



- 1. (Sul-R:1245)
- 2. Tawny Tan (Sul-R:1055)
- 3. (Sul-R:1245)
- 4. Temple Gold (Sul-R:1159)

**Gfe-Ccr-1-4b.vp3**  
5.74x4.98 inches; 12,727 stitches  
4 thread changes; 3 colors



- 1. Tawny Tan (Sul-R:1055)
- 2. (Sul-R:1245)
- 3. Temple Gold (Sul-R:1159)

**Gfe-Ccr-1-4c.vp3**  
1.46x5.24 inches; 4,582 stitches  
3 thread changes; 3 colors



- 1. (Sul-R:1245)
- 2. Tawny Tan (Sul-R:1055)
- 3. (Sul-R:1245)
- 4. Temple Gold (Sul-R:1159)

**Gfe-Ccr-1-4d.vp3**  
3.81x5.01 inches; 8,633 stitches  
4 thread changes; 3 colors



- 1. (Sul-R:1245)
- 2. Tawny Tan (Sul-R:1055)
- 3. (Sul-R:1245)
- 4. Temple Gold (Sul-R:1159)

**Gfe-Ccr-1-4e.vp3**

5.74x4.88 inches; 12,373 stitches  
4 thread changes; 3 colors

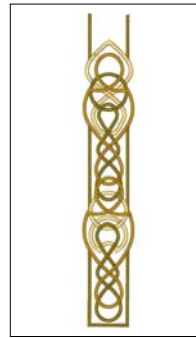

- 1. (Sul-R:1245)
- 2. Tawny Tan (Sul-R:1055)
- 3. (Sul-R:1245)
- 4. Temple Gold (Sul-R:1159)

**Gfe-Ccr-1-4f.vp3**

1.04x6.29 inches; 5,806 stitches  
4 thread changes; 3 colors



- 1. Tawny Tan (Sul-R:1055)
- 2. (Sul-R:1245)
- 3. Temple Gold (Sul-R:1159)
- 4. (Sul-R:1245)
- 5. Temple Gold (Sul-R:1159)
- 6. (Sul-R:1245)
- 7. Tawny Tan (Sul-R:1055)

**Gfe-Ccr-Freebie.vp3**

1.53x3.40 inches; 3,331 stitches  
7 thread changes; 3 colors