

Printed 4/1/2020

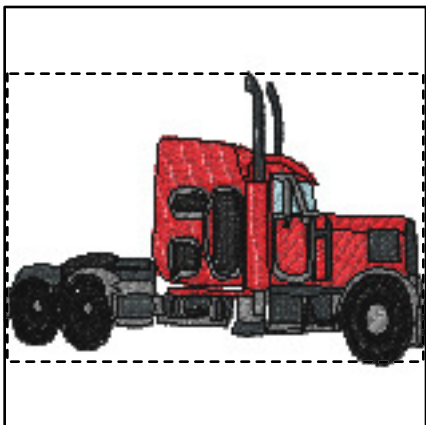

- 1. Light Blue (Bro:17)
- 2. Red (Bro:800)
- 3. Dark Gray (Bro:707)
- 4. Gray (Bro:817)
- 5. Black (Bro:900)

Eo870-01-4x4.pes

3.91x2.71 inches; 18,644 stitches
5 thread changes; 5 colors

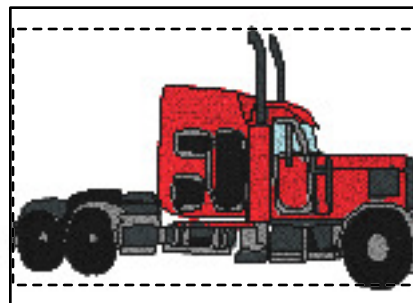

- 1. Light Blue (Bro:17)
- 2. Red (Bro:800)
- 3. Dark Gray (Bro:707)
- 4. Gray (Bro:817)
- 5. Black (Bro:900)

Eo870-01-5x7.pes

6.98x4.39 inches; 35,936 stitches
5 thread changes; 5 colors

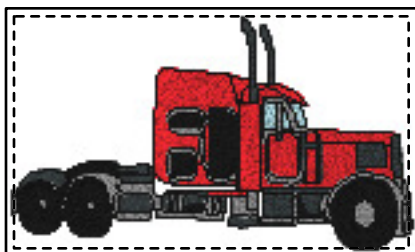

- 1. Light Blue (Bro:17)
- 2. Red (Bro:800)
- 3. Dark Gray (Bro:707)
- 4. Gray (Bro:817)
- 5. Black (Bro:900)

Eo870-01-6x10.pes

9.91x5.79 inches; 54,335 stitches
5 thread changes; 5 colors

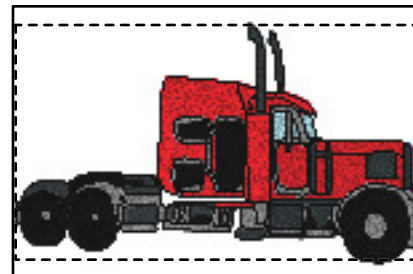

- 1. Light Blue (Bro:17)
- 2. Red (Bro:800)
- 3. Dark Gray (Bro:707)
- 4. Gray (Bro:817)
- 5. Black (Bro:900)

Eo870-01-8x12.pes

11.60x6.77 inches; 67,446 stitches
5 thread changes; 5 colors

Printed 4/1/2020



- 1. Light Blue (Bro:17)
- 2. Red (Bro:800)
- 3. Dark Gray (Bro:707)
- 4. Gray (Bro:817)
- 5. Black (Bro:900)

Eo870-01-8x14.pes

13.55x7.64 inches; 82,445 stitches
5 thread changes; 5 colors

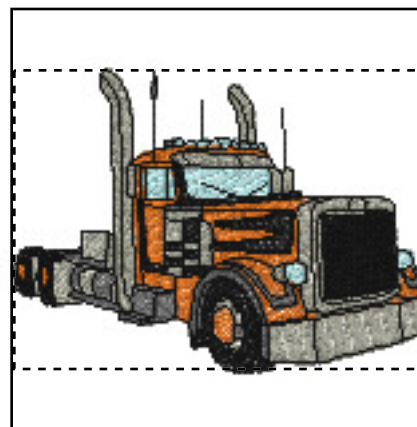

- 1. Light Blue
- 2. Vermilion
- 3. Dark Gray
- 4. Gray
- 5. Black

Eo870-02-4x4.pes

3.89x2.81 inches; 21,223 stitches
5 thread changes; 5 colors

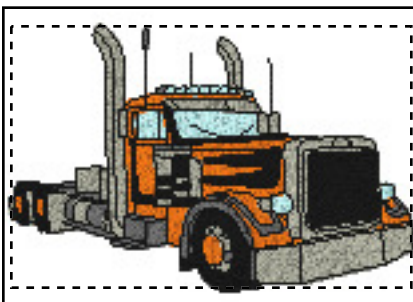

- 1. Light Blue
- 2. Vermilion
- 3. Dark Gray
- 4. Gray
- 5. Black

Eo870-02-5x7.pes

6.83x4.50 inches; 41,826 stitches
5 thread changes; 5 colors



- 1. Light Blue
- 2. Vermilion
- 3. Dark Gray
- 4. Gray
- 5. Black

Eo870-02-6x10.pes

8.97x5.93 inches; 60,454 stitches
5 thread changes; 5 colors

Printed 4/1/2020

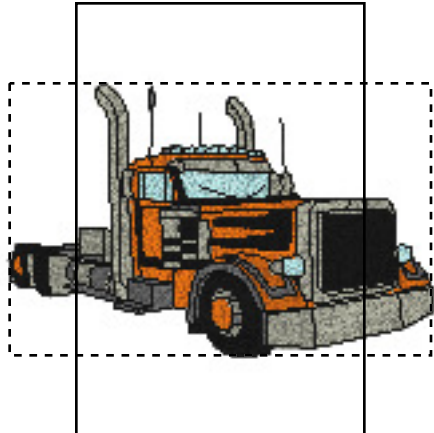

- 1. Light Blue
- 2. Vermilion
- 3. Dark Gray
- 4. Gray
- 5. Black

Eo870-02-8x12.pes
11.48x7.39 inches; 82,704 stitches
5 thread changes; 5 colors

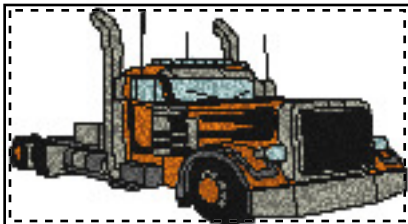

- 1. Light Blue
- 2. Vermilion
- 3. Dark Gray
- 4. Gray
- 5. Black

Eo870-02-8x14.pes
13.79x7.46 inches; 95,129 stitches
5 thread changes; 5 colors

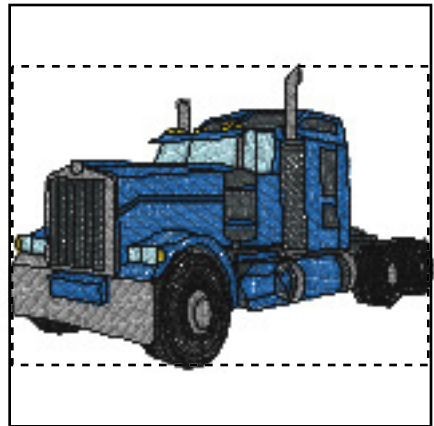

- 1. Light Blue (Bro:17)
- 2. Dark Gray (Bro:707)
- 3. Harvest Gold (Bro:206)
- 4. Gray (Bro:817)
- 5. Blue (Bro:405)
- 6. Black (Bro:900)

Eo870-03-4x4.pes
3.90x2.80 inches; 20,072 stitches
6 thread changes; 6 colors



- 1. Light Blue (Bro:17)
- 2. Dark Gray (Bro:707)
- 3. Harvest Gold (Bro:206)
- 4. Gray (Bro:817)
- 5. Blue (Bro:405)
- 6. Black (Bro:900)

Eo870-03-5x7.pes
6.93x4.72 inches; 41,696 stitches
6 thread changes; 6 colors

Printed 4/1/2020



- 1. Light Blue (Bro:17)
- 2. Dark Gray (Bro:707)
- 3. Harvest Gold (Bro:206)
- 4. Gray (Bro:817)
- 5. Blue (Bro:405)
- 6. Black (Bro:900)

Eo870-03-6x10.pes

9.69x5.92 inches; 61,499 stitches
6 thread changes; 6 colors

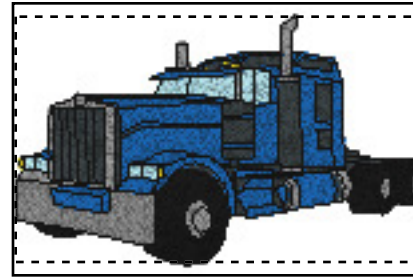

- 1. Light Blue (Bro:17)
- 2. Dark Gray (Bro:707)
- 3. Harvest Gold (Bro:206)
- 4. Gray (Bro:817)
- 5. Blue (Bro:405)
- 6. Black (Bro:900)

Eo870-03-8x12.pes

11.58x7.08 inches; 79,614 stitches
6 thread changes; 6 colors

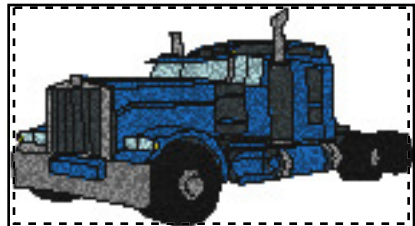

- 1. Light Blue (Bro:17)
- 2. Dark Gray (Bro:707)
- 3. Harvest Gold (Bro:206)
- 4. Gray (Bro:817)
- 5. Blue (Bro:405)
- 6. Black (Bro:900)

Eo870-03-8x14.pes

13.83x7.51 inches; 95,545 stitches
6 thread changes; 6 colors

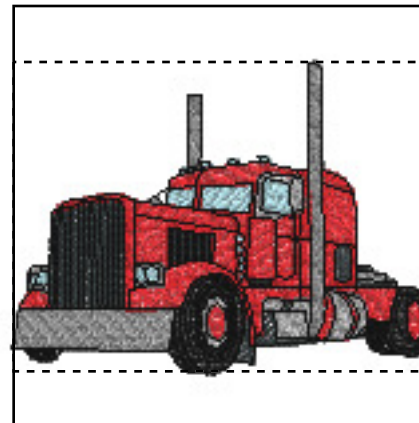

- 1. Light Blue (Bro:17)
- 2. Dark Gray (Bro:707)
- 3. Gray (Bro:817)
- 4. Red (Bro:800)
- 5. Silver (Bro:5)
- 6. Black (Bro:900)

Eo870-04-4x4.pes

3.93x2.90 inches; 19,353 stitches
6 thread changes; 6 colors

Printed 4/1/2020

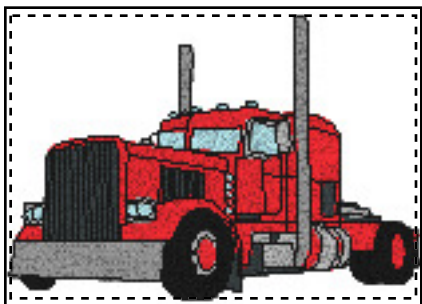

- 1. Light Blue (Bro:17)
- 2. Dark Gray (Bro:707)
- 3. Gray (Bro:817)
- 4. Red (Bro:800)
- 5. Silver (Bro:5)
- 6. Black (Bro:900)

Eo870-04-5x7.pes

6.92x4.81 inches; 39,178 stitches
6 thread changes; 6 colors



- 1. Light Blue (Bro:17)
- 2. Dark Gray (Bro:707)
- 3. Gray (Bro:817)
- 4. Red (Bro:800)
- 5. Silver (Bro:5)
- 6. Black (Bro:900)

Eo870-04-6x10.pes

9.97x6.05 inches; 58,219 stitches
6 thread changes; 6 colors

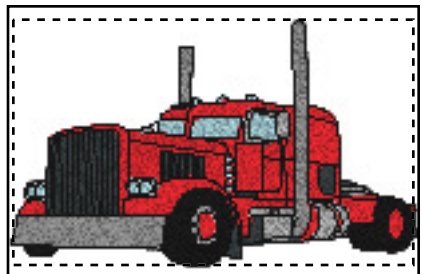

- 1. Light Blue (Bro:17)
- 2. Dark Gray (Bro:707)
- 3. Gray (Bro:817)
- 4. Red (Bro:800)
- 5. Silver (Bro:5)
- 6. Black (Bro:900)

Eo870-04-8x12.pes

11.50x6.98 inches; 71,870 stitches
6 thread changes; 6 colors

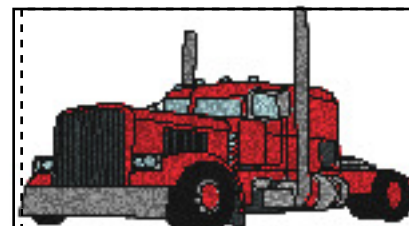

- 1. Light Blue (Bro:17)
- 2. Dark Gray (Bro:707)
- 3. Gray (Bro:817)
- 4. Red (Bro:800)
- 5. Silver (Bro:5)
- 6. Black (Bro:900)

Eo870-04-8x14.pes

13.70x7.83 inches; 88,327 stitches
6 thread changes; 6 colors

Printed 4/1/2020

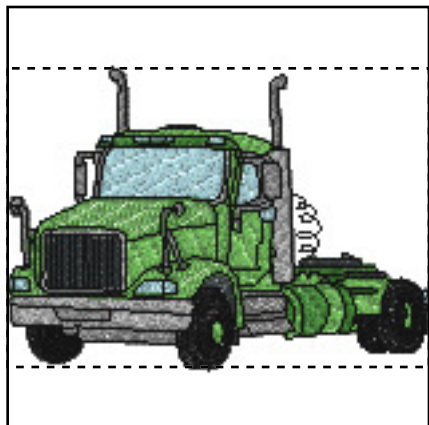

- 1. Light Blue (Bro:17)
- 2. Dark Gray (Bro:707)
- 3. Gray (Bro:817)
- 4. Silver (Bro:5)
- 5. Leaf Green (Bro:509)
- 6. Moss Green (Bro:515)
- 7. Black (Bro:900)

Eo870-05-4x4.pes

3.92x2.80 inches; 21,352 stitches
7 thread changes; 7 colors

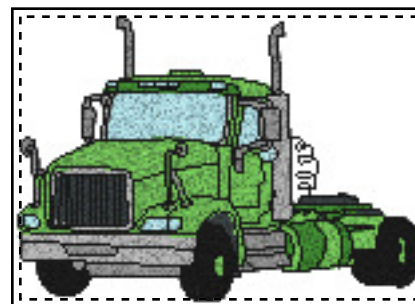

- 1. Light Blue (Bro:17)
- 2. Dark Gray (Bro:707)
- 3. Gray (Bro:817)
- 4. Silver (Bro:5)
- 5. Leaf Green (Bro:509)
- 6. Moss Green (Bro:515)
- 7. Black (Bro:900)

Eo870-05-5x7.pes

6.82x4.80 inches; 41,222 stitches
7 thread changes; 7 colors

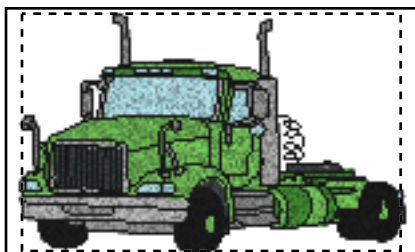

- 1. Light Blue (Bro:17)
- 2. Dark Gray (Bro:707)
- 3. Gray (Bro:817)
- 4. Silver (Bro:5)
- 5. Leaf Green (Bro:509)
- 6. Moss Green (Bro:515)
- 7. Black (Bro:900)

Eo870-05-6x10.pes

9.54x5.98 inches; 60,070 stitches
7 thread changes; 7 colors

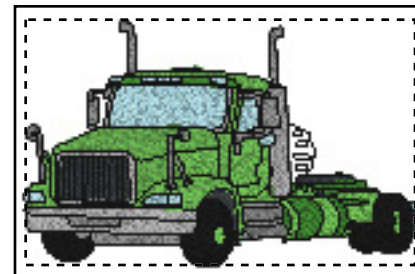

- 1. Light Blue (Bro:17)
- 2. Dark Gray (Bro:707)
- 3. Gray (Bro:817)
- 4. Silver (Bro:5)
- 5. Leaf Green (Bro:509)
- 6. Moss Green (Bro:515)
- 7. Black (Bro:900)

Eo870-05-8x12.pes

11.15x6.98 inches; 74,465 stitches
7 thread changes; 7 colors

Printed 4/1/2020

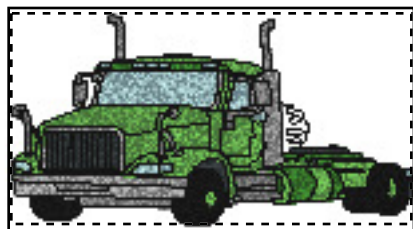

- 1. Light Blue (Bro:17)
- 2. Dark Gray (Bro:707)
- 3. Gray (Bro:817)
- 4. Silver (Bro:5)
- 5. Leaf Green (Bro:509)
- 6. Moss Green (Bro:515)
- 7. Black (Bro:900)

Eo870-05-8x14.pes

13.96x7.34 inches; 91,310 stitches
7 thread changes; 7 colors

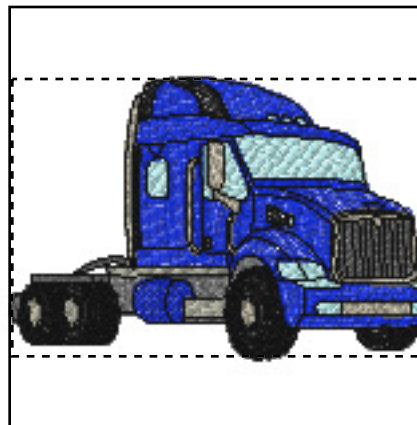

- 1. Light Blue
- 2. Dark Gray
- 3. Ultramarine
- 4. Silver
- 5. Gray
- 6. Black

Eo870-06-4x4.pes

3.89x2.61 inches; 23,055 stitches
6 thread changes; 6 colors

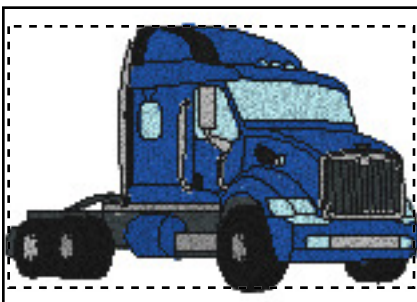

- 1. Light Blue (Bro:17)
- 2. Dark Gray (Bro:707)
- 3. Ultramarine (Bro:406)
- 4. Silver (Bro:5)
- 5. Gray (Bro:817)
- 6. Black (Bro:900)

Eo870-06-5x7.pes

6.91x4.47 inches; 46,622 stitches
6 thread changes; 6 colors



- 1. Light Blue (Bro:17)
- 2. Dark Gray (Bro:707)
- 3. Ultramarine (Bro:406)
- 4. Silver (Bro:5)
- 5. Gray (Bro:817)
- 6. Black (Bro:900)

Eo870-06-6x10.pes

9.60x5.81 inches; 69,291 stitches
6 thread changes; 6 colors

Printed 4/1/2020

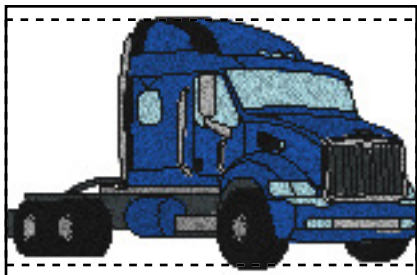

- 1. Light Blue (Bro:17)
- 2. Dark Gray (Bro:707)
- 3. Ultramarine (Bro:406)
- 4. Silver (Bro:5)
- 5. Gray (Bro:817)
- 6. Black (Bro:900)

Eo870-06-8x12.pes

11.74x7.12 inches; 92,262 stitches
6 thread changes; 6 colors

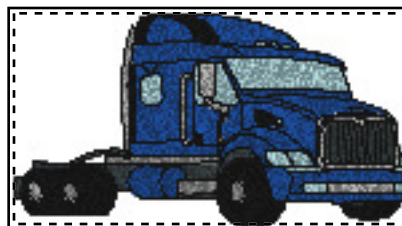

- 1. Light Blue (Bro:17)
- 2. Dark Gray (Bro:707)
- 3. Ultramarine (Bro:406)
- 4. Silver (Bro:5)
- 5. Gray (Bro:817)
- 6. Black (Bro:900)

Eo870-06-8x14.pes

13.78x7.37 inches; 106,846 stitches
6 thread changes; 6 colors

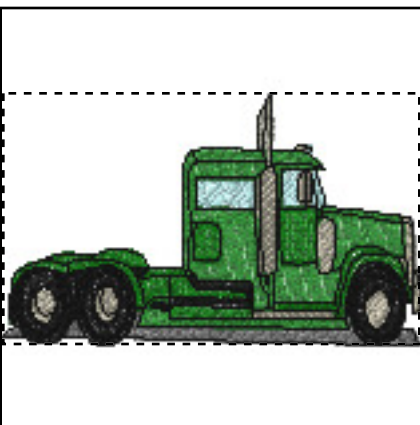

- 1. Dark Gray
- 2. Light Blue
- 3. Gray
- 4. Silver
- 5. Emerald Green
- 6. Deep Green
- 7. Black

Eo870-07-4x4.pes

3.91x2.34 inches; 15,764 stitches
7 thread changes; 7 colors

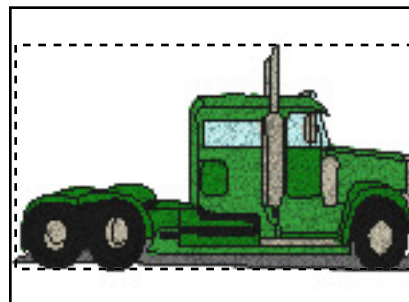

- 1. Dark Gray
- 2. Light Blue
- 3. Gray
- 4. Silver
- 5. Emerald Green
- 6. Deep Green
- 7. Black

Eo870-07-5x7.pes

6.92x3.80 inches; 31,899 stitches
7 thread changes; 7 colors

Printed 4/1/2020

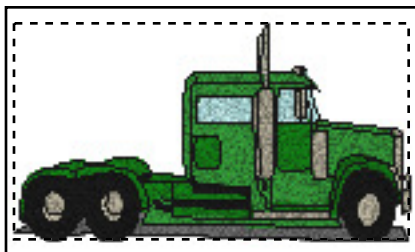

- 1. Dark Gray
- 2. Light Blue
- 3. Gray
- 4. Silver
- 5. Emerald Green
- 6. Deep Green
- 7. Emerald Green
- 8. Black

Eo870-07-6x10.pes

9.89x5.43 inches; 52,265 stitches
8 thread changes; 7 colors

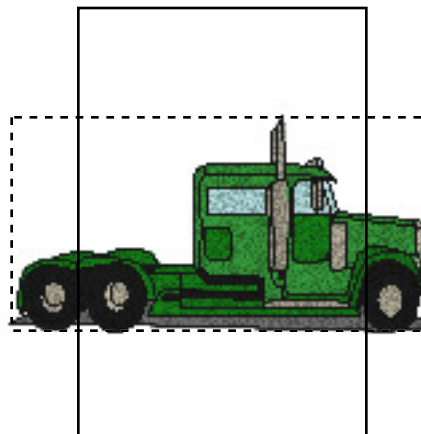

- 1. Dark Gray
- 2. Light Blue
- 3. Gray
- 4. Silver
- 5. Emerald Green
- 6. Deep Green
- 7. Black

Eo870-07-8x12.pes

11.57x5.88 inches; 61,691 stitches
7 thread changes; 7 colors

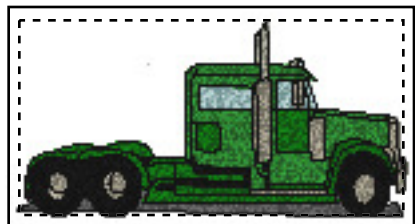

- 1. Dark Gray
- 2. Light Blue
- 3. Gray
- 4. Silver
- 5. Emerald Green
- 6. Deep Green
- 7. Black

Eo870-07-8x14.pes

13.44x6.84 inches; 77,412 stitches
7 thread changes; 7 colors

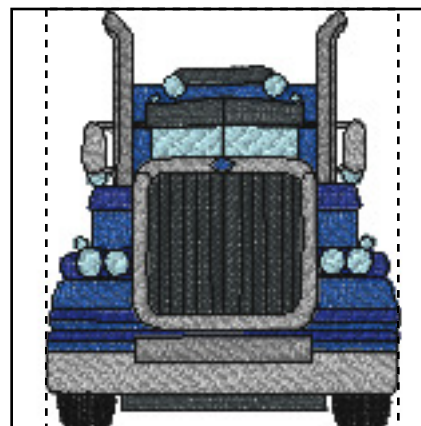

- 1. Light Blue (Bro:17)
- 2. Ultramarine (Bro:406)
- 3. Prussian Blue (Bro:7)
- 4. Dark Gray (Bro:707)
- 5. Gray (Bro:817)
- 6. Silver (Bro:5)
- 7. Black (Bro:900)

Eo870-08-4x4.pes

3.28x3.93 inches; 25,387 stitches
7 thread changes; 7 colors

Printed 4/1/2020

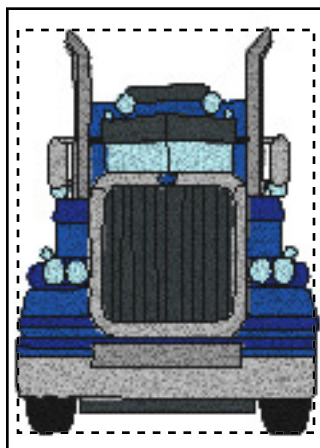

- 1. Light Blue (Bro:17)
- 2. Ultramarine (Bro:406)
- 3. Prussian Blue (Bro:7)
- 4. Dark Gray (Bro:707)
- 5. Gray (Bro:817)
- 6. Silver (Bro:5)
- 7. Black (Bro:900)

Eo870-08-5x7 pes

4.78x6.45 inches; 46,125 stitches
7 thread changes; 7 colors

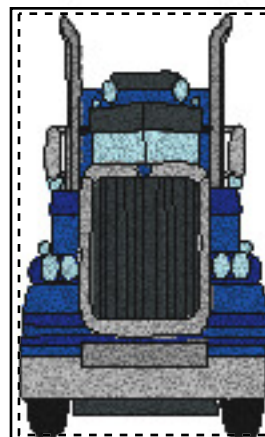

- 1. Light Blue (Bro:17)
- 2. Ultramarine (Bro:406)
- 3. Prussian Blue (Bro:7)
- 4. Dark Gray (Bro:707)
- 5. Gray (Bro:817)
- 6. Silver (Bro:5)
- 7. Black (Bro:900)

Eo870-08-6x10 pes

5.85x9.93 inches; 74,656 stitches
7 thread changes; 7 colors

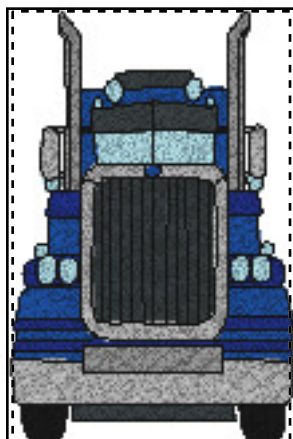

- 1. Light Blue (Bro:17)
- 2. Ultramarine (Bro:406)
- 3. Prussian Blue (Bro:7)
- 4. Dark Gray (Bro:707)
- 5. Gray (Bro:817)
- 6. Silver (Bro:5)
- 7. Black (Bro:900)

Eo870-08-8x12 pes

7.54x11.61 inches; 102,044 stitches
7 thread changes; 7 colors

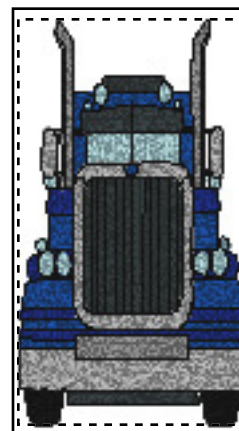

- 1. Light Blue (Bro:17)
- 2. Ultramarine (Bro:406)
- 3. Prussian Blue (Bro:7)
- 4. Dark Gray (Bro:707)
- 5. Gray (Bro:817)
- 6. Silver (Bro:5)
- 7. Black (Bro:900)

Eo870-08-8x14 pes

7.43x13.35 inches; 113,861 stitches
7 thread changes; 7 colors

Printed 4/1/2020

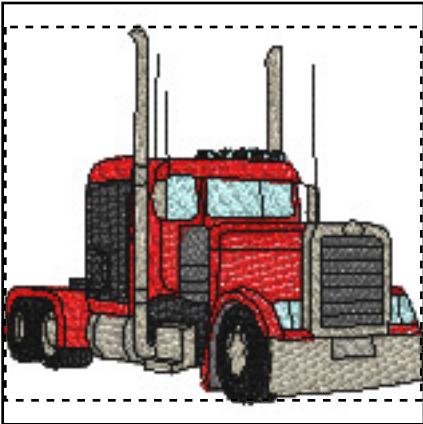

- 1. Light Blue
- 2. Dark Gray
- 3. Silver
- 4. Gray
- 5. Red
- 6. Black

Eo870-09-4x4.pes
3.90x3.49 inches; 18,807 stitches
6 thread changes; 6 colors

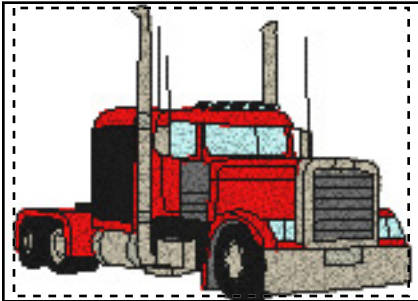

- 1. Light Blue
- 2. Dark Gray
- 3. Silver
- 4. Gray
- 5. Red
- 6. Black

Eo870-09-5x7.pes
6.70x4.94 inches; 37,381 stitches
6 thread changes; 6 colors

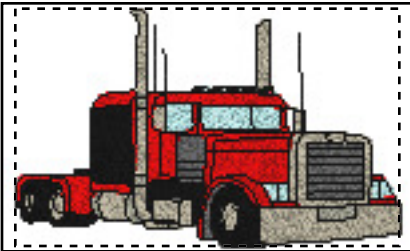

- 1. Light Blue
- 2. Dark Gray
- 3. Silver
- 4. Gray
- 5. Red
- 6. Black

Eo870-09-6x10.pes
9.61x5.98 inches; 54,541 stitches
6 thread changes; 6 colors

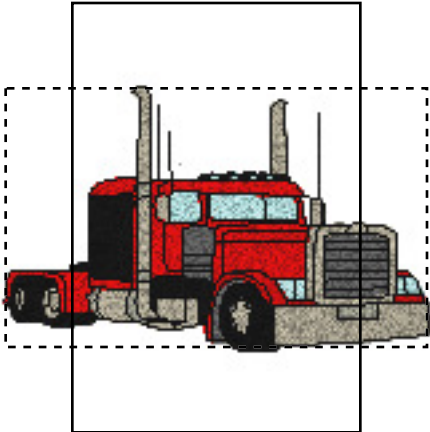

- 1. Light Blue
- 2. Dark Gray
- 3. Silver
- 4. Gray
- 5. Red
- 6. Black

Eo870-09-8x12.pes
11.57x7.18 inches; 71,104 stitches
6 thread changes; 6 colors

Printed 4/1/2020

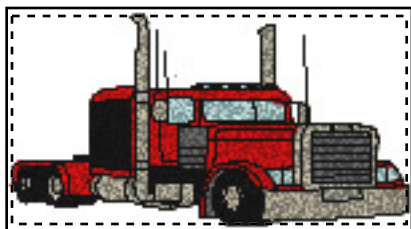

- 1. Light Blue
- 2. Dark Gray
- 3. Silver
- 4. Gray
- 5. Red
- 6. Black

Eo870-09-8x14.pes

13.80x7.32 inches; 82,662 stitches
6 thread changes; 6 colors

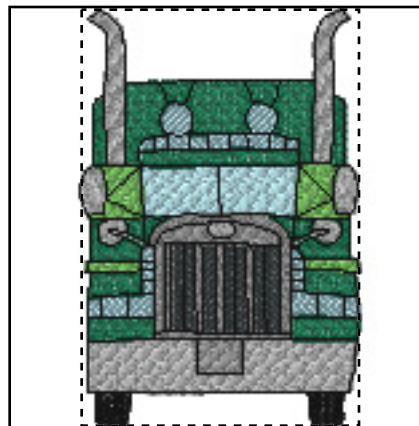

- 1. Light Blue (Bro:17)
- 2. Dark Gray (Bro:707)
- 3. Gray (Bro:817)
- 4. Silver (Bro:5)
- 5. Emerald Green (Bro:507)
- 6. Leaf Green (Bro:509)
- 7. Black (Bro:900)

Eo870-10-4x4.pes

2.59x3.89 inches; 20,244 stitches
7 thread changes; 7 colors

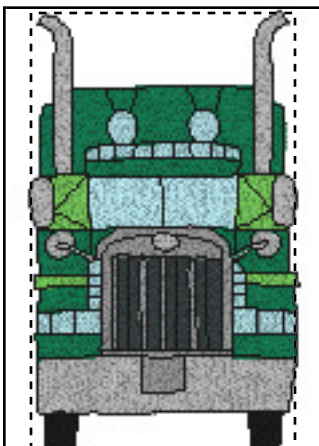

- 1. Light Blue (Bro:17)
- 2. Dark Gray (Bro:707)
- 3. Gray (Bro:817)
- 4. Silver (Bro:5)
- 5. Emerald Green (Bro:507)
- 6. Leaf Green (Bro:509)
- 7. Black (Bro:900)

Eo870-10-5x7.pes

4.26x6.96 inches; 42,774 stitches
7 thread changes; 7 colors

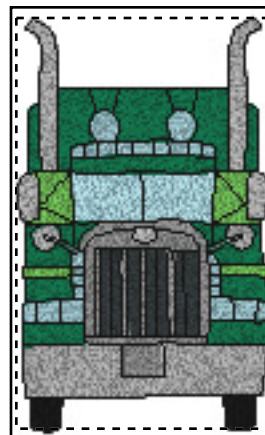

- 1. Light Blue (Bro:17)
- 2. Dark Gray (Bro:707)
- 3. Gray (Bro:817)
- 4. Silver (Bro:5)
- 5. Emerald Green (Bro:507)
- 6. Leaf Green (Bro:509)
- 7. Black (Bro:900)

Eo870-10-6x10.pes

5.94x9.70 inches; 70,934 stitches
7 thread changes; 7 colors

Printed 4/1/2020

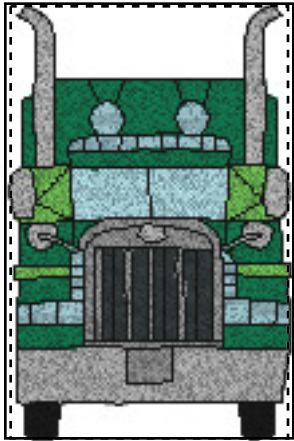

- 1. Light Blue (Bro:17)
- 2. Dark Gray (Bro:707)
- 3. Gray (Bro:817)
- 4. Silver (Bro:5)
- 5. Emerald Green (Bro:507)
- 6. Leaf Green (Bro:509)
- 7. Black (Bro:900)

Eo870-10-8x12.pes

7.54x11.68 inches; 99,254 stitches
7 thread changes; 7 colors

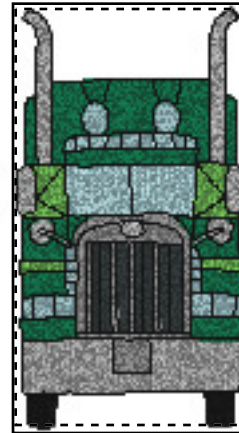

- 1. Light Blue (Bro:17)
- 2. Dark Gray (Bro:707)
- 3. Gray (Bro:817)
- 4. Silver (Bro:5)
- 5. Emerald Green (Bro:507)
- 6. Leaf Green (Bro:509)
- 7. Black (Bro:900)

Eo870-10-8x14.pes

7.61x13.78 inches; 115,035 stitches
7 thread changes; 7 colors

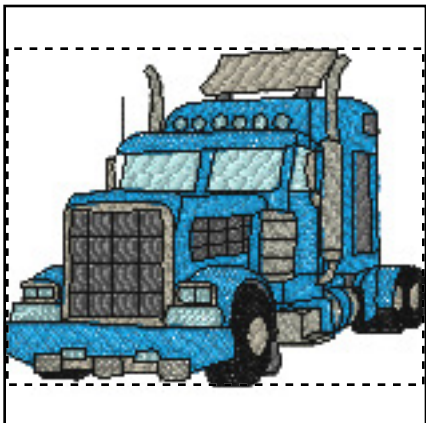

- 1. Light Blue
- 2. Dark Gray
- 3. Silver
- 4. Gray
- 5. Electric Blue
- 6. Black

Eo870-11-4x4.pes

3.89x3.12 inches; 25,115 stitches
6 thread changes; 6 colors

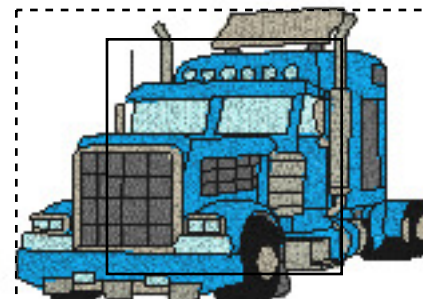

- 1. Light Blue
- 2. Dark Gray
- 3. Silver
- 4. Gray
- 5. Electric Blue
- 6. Black

Eo870-11-5x7.pes

6.93x4.96 inches; 49,504 stitches
6 thread changes; 6 colors

Printed 4/1/2020

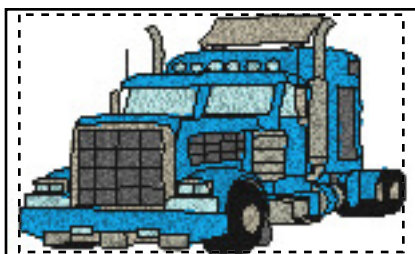

- 1. Light Blue
- 2. Dark Gray
- 3. Silver
- 4. Gray
- 5. Electric Blue
- 6. Black

Eo870-11-6x10.pes

9.59x5.94 inches; 71,508 stitches
6 thread changes; 6 colors

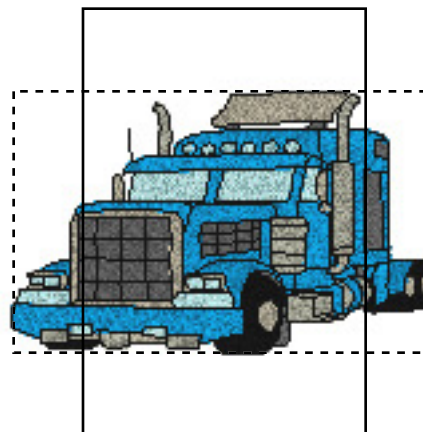

- 1. Light Blue
- 2. Dark Gray
- 3. Silver
- 4. Gray
- 5. Electric Blue
- 6. Black

Eo870-11-8x14.pes

11.64x7.21 inches; 95,049 stitches
6 thread changes; 6 colors

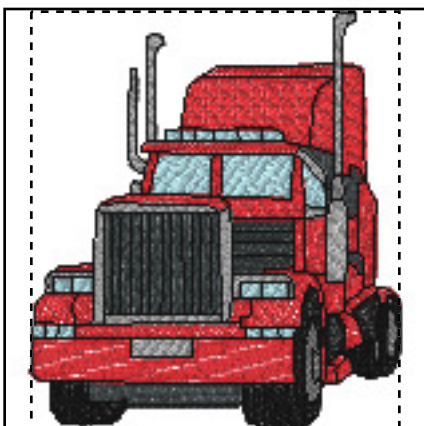

- 1. Light Blue (Bro:17)
- 2. Dark Gray (Bro:707)
- 3. Red (Bro:800)
- 4. Silver (Bro:5)
- 5. Gray (Bro:817)
- 6. Black (Bro:900)

Eo870-12-4x4.pes

3.44x3.89 inches; 24,039 stitches
6 thread changes; 6 colors

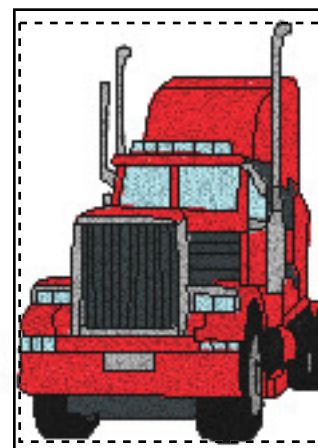

- 1. Light Blue (Bro:17)
- 2. Dark Gray (Bro:707)
- 3. Red (Bro:800)
- 4. Silver (Bro:5)
- 5. Gray (Bro:817)
- 6. Black (Bro:900)

Eo870-12-5x7.pes

4.96x6.69 inches; 43,630 stitches
6 thread changes; 6 colors

Printed 4/1/2020

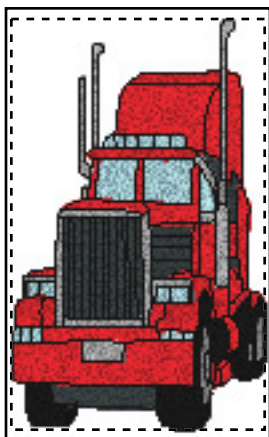

- 1. Light Blue (Bro:17)
- 2. Dark Gray (Bro:707)
- 3. Red (Bro:800)
- 4. Silver (Bro:5)
- 5. Gray (Bro:817)
- 6. Black (Bro:900)

Eo870-12-6x10.pes

5.97x9.66 inches; 65,923 stitches
6 thread changes; 6 colors

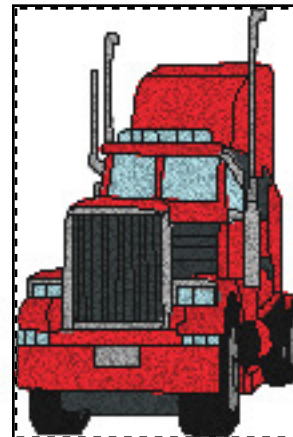

- 1. Light Blue (Bro:17)
- 2. Dark Gray (Bro:707)
- 3. Red (Bro:800)
- 4. Silver (Bro:5)
- 5. Gray (Bro:817)
- 6. Black (Bro:900)

Eo870-12-8x12.pes

7.70x11.59 inches; 91,769 stitches
6 thread changes; 6 colors



- 1. Light Blue (Bro:17)
- 2. Dark Gray (Bro:707)
- 3. Red (Bro:800)
- 4. Silver (Bro:5)
- 5. Gray (Bro:817)
- 6. Black (Bro:900)

Eo870-12-8x14.pes

7.63x13.72 inches; 104,655 stitches
6 thread changes; 6 colors

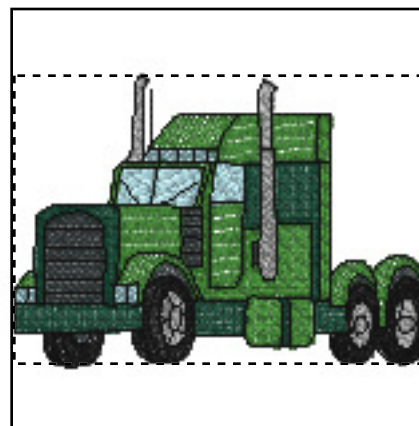

- 1. Light Blue (Bro:17)
- 2. Dark Gray (Bro:707)
- 3. Silver (Bro:5)
- 4. Moss Green (Bro:515)
- 5. Deep Green (Bro:808)
- 6. Black (Bro:900)

Eo870-13-4x4.pes

3.87x2.71 inches; 17,528 stitches
6 thread changes; 6 colors

Printed 4/1/2020

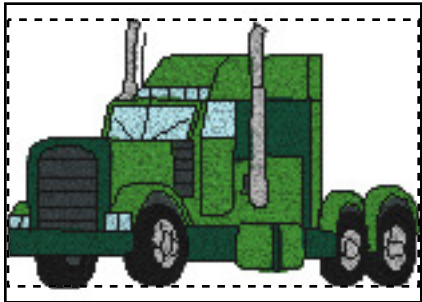

- 1. Light Blue (Bro:17)
- 2. Dark Gray (Bro:707)
- 3. Silver (Bro:5)
- 4. Moss Green (Bro:515)
- 5. Deep Green (Bro:808)
- 6. Black (Bro:900)

Eo870-13-5x7.pes

6.94x4.52 inches; 38,195 stitches
6 thread changes; 6 colors



- 1. Light Blue (Bro:17)
- 2. Dark Gray (Bro:707)
- 3. Silver (Bro:5)
- 4. Moss Green (Bro:515)
- 5. Deep Green (Bro:808)
- 6. Black (Bro:900)

Eo870-13-6x10.pes

9.91x5.79 inches; 59,432 stitches
6 thread changes; 6 colors

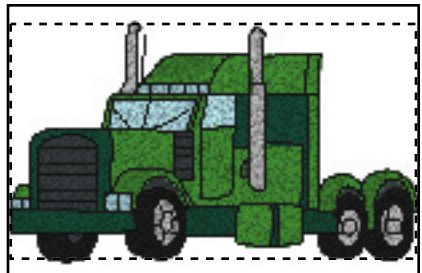

- 1. Light Blue (Bro:17)
- 2. Dark Gray (Bro:707)
- 3. Silver (Bro:5)
- 4. Moss Green (Bro:515)
- 5. Deep Green (Bro:808)
- 6. Black (Bro:900)

Eo870-13-8x12.pes

11.59x6.77 inches; 75,321 stitches
6 thread changes; 6 colors

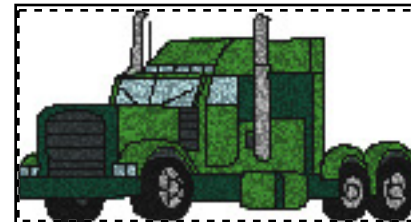

- 1. Light Blue (Bro:17)
- 2. Dark Gray (Bro:707)
- 3. Silver (Bro:5)
- 4. Moss Green (Bro:515)
- 5. Deep Green (Bro:808)
- 6. Black (Bro:900)

Eo870-13-8x14.pes

13.92x7.35 inches; 93,227 stitches
6 thread changes; 6 colors

Printed 4/1/2020

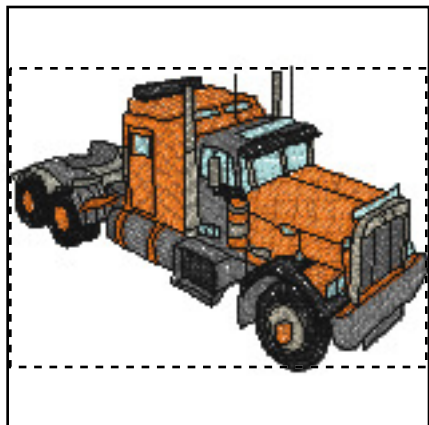

- 1. Light Blue
- 2. Dark Gray
- 3. Vermilion
- 4. Black
- 5. Silver
- 6. Gray
- 7. Black

Eo870-14-4x4.pes

3.87x2.81 inches; 19,702 stitches
7 thread changes; 6 colors

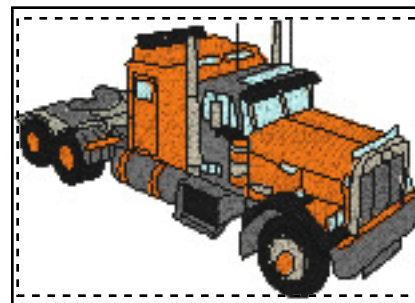

- 1. Light Blue
- 2. Dark Gray
- 3. Vermilion
- 4. Black
- 5. Silver
- 6. Gray
- 7. Black

Eo870-14-5x7.pes

6.91x4.72 inches; 39,024 stitches
7 thread changes; 6 colors



- 1. Light Blue
- 2. Dark Gray
- 3. Vermilion
- 4. Black
- 5. Silver
- 6. Gray
- 7. Black

Eo870-14-6x10.pes

9.58x5.92 inches; 56,850 stitches
7 thread changes; 6 colors

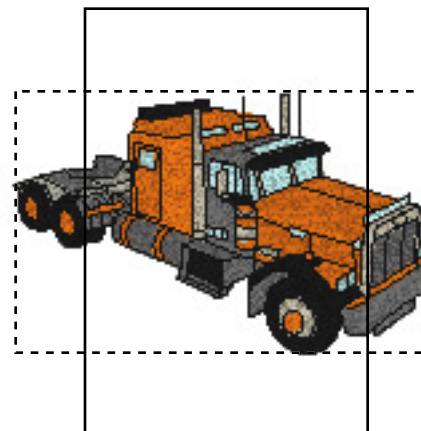

- 1. Light Blue
- 2. Dark Gray
- 3. Vermilion
- 4. Black
- 5. Silver
- 6. Gray
- 7. Black

Eo870-14-8x12.pes

11.66x7.20 inches; 75,789 stitches
7 thread changes; 6 colors

Printed 4/1/2020



- 1. Dark Gray (Bro:707)
- 2. Light Blue (Bro:17)
- 3. Vermilion (Bro:30)
- 4. Black (Bro:900)
- 5. Silver (Bro:5)
- 6. Gray (Bro:817)
- 7. Black (Bro:900)

Eo870-14-8x14.pes

13.78x7.71 inches; 90,564 stitches
7 thread changes; 6 colors

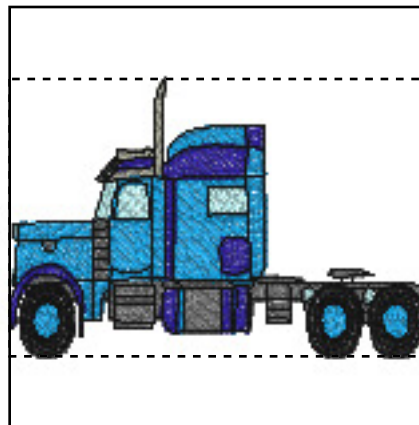

- 1. Light Blue
- 2. Dark Gray
- 3. Gray
- 4. Electric Blue
- 5. Prussian Blue
- 6. Black

Eo870-15-4x4.pes

3.91x2.59 inches; 13,490 stitches
6 thread changes; 6 colors

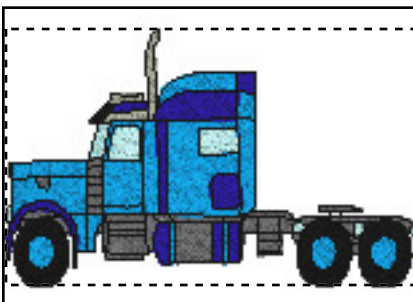

- 1. Light Blue
- 2. Dark Gray
- 3. Gray
- 4. Electric Blue
- 5. Prussian Blue
- 6. Black

Eo870-15-5x7.pes

6.98x4.36 inches; 29,043 stitches
6 thread changes; 6 colors

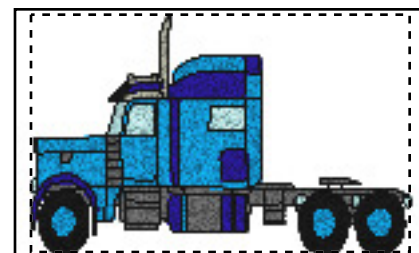

- 1. Light Blue
- 2. Dark Gray
- 3. Gray
- 4. Electric Blue
- 5. Prussian Blue
- 6. Black

Eo870-15-6x10.pes

9.47x5.98 inches; 44,777 stitches
6 thread changes; 6 colors

Printed 4/1/2020

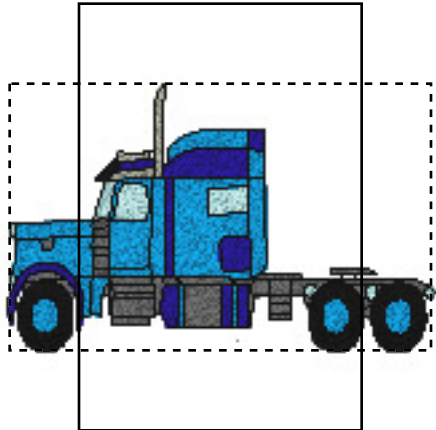

- 1. Light Blue
- 2. Dark Gray
- 3. Gray
- 4. Electric Blue
- 5. Prussian Blue
- 6. Black

Eo870-15-8x12.pes
 11.66x7.34 inches; 60,513 stitches
 6 thread changes; 6 colors



- 1. Light Blue
- 2. Dark Gray
- 3. Gray
- 4. Electric Blue
- 5. Prussian Blue
- 6. Black

Eo870-15-8x14.pes
 13.87x7.42 inches; 69,363 stitches
 6 thread changes; 6 colors

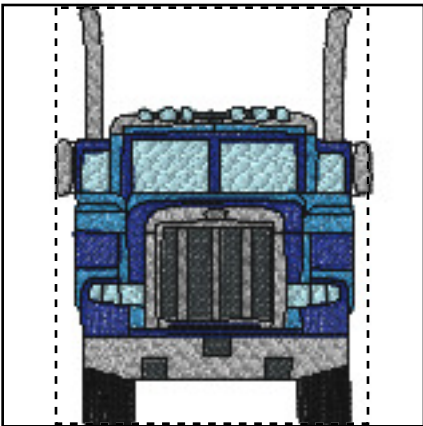

- 1. Light Blue (Bro:17)
- 2. Dark Gray (Bro:707)
- 3. Sky Blue (Bro:19)
- 4. Silver (Bro:5)
- 5. Gray (Bro:817)
- 6. Prussian Blue (Bro:7)
- 7. Black (Bro:900)

Eo870-16-4x4.pes
 2.92x3.89 inches; 21,248 stitches
 7 thread changes; 7 colors

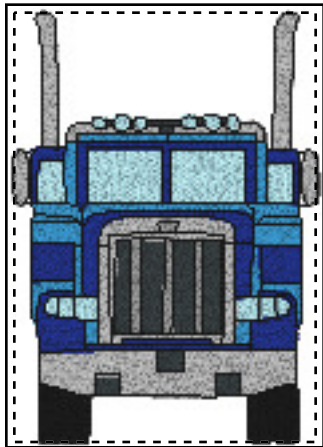

- 1. Light Blue (Bro:17)
- 2. Dark Gray (Bro:707)
- 3. Sky Blue (Bro:19)
- 4. Silver (Bro:5)
- 5. Gray (Bro:817)
- 6. Prussian Blue (Bro:7)
- 7. Black (Bro:900)

Eo870-16-5x7.pes
 4.87x6.89 inches; 43,503 stitches
 7 thread changes; 7 colors

Printed 4/1/2020

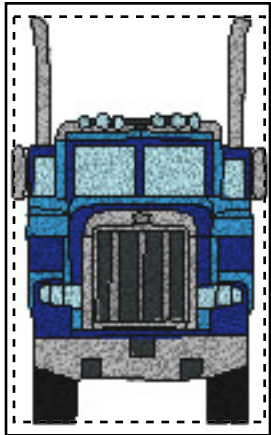

- 1. Light Blue (Bro:17)
- 2. Dark Gray (Bro:707)
- 3. Sky Blue (Bro:19)
- 4. Silver (Bro:5)
- 5. Gray (Bro:817)
- 6. Prussian Blue (Bro:7)
- 7. Black (Bro:900)

Eo870-16-6x10.pes

5.94x9.55 inches; 63,480 stitches
7 thread changes; 7 colors

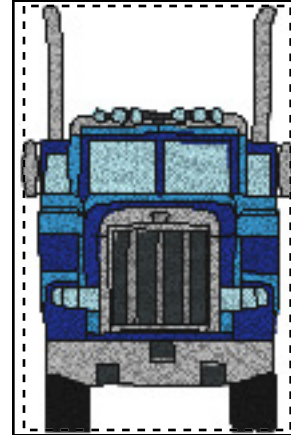

- 1. Light Blue (Bro:17)
- 2. Dark Gray (Bro:707)
- 3. Sky Blue (Bro:19)
- 4. Silver (Bro:5)
- 5. Gray (Bro:817)
- 6. Prussian Blue (Bro:7)
- 7. Black (Bro:900)

Eo870-16-8x12.pes

7.27x11.45 inches; 84,918 stitches
7 thread changes; 7 colors

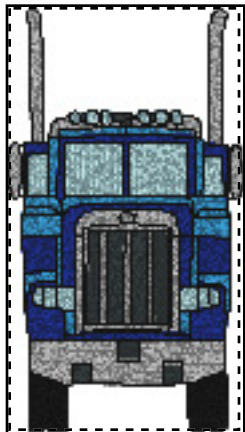

- 1. Light Blue (Bro:17)
- 2. Dark Gray (Bro:707)
- 3. Sky Blue (Bro:19)
- 4. Silver (Bro:5)
- 5. Gray (Bro:817)
- 6. Prussian Blue (Bro:7)
- 7. Black (Bro:900)

Eo870-16-8x14.pes

7.65x13.83 inches; 103,277 stitches
7 thread changes; 7 colors