

Printed 12/5/2018

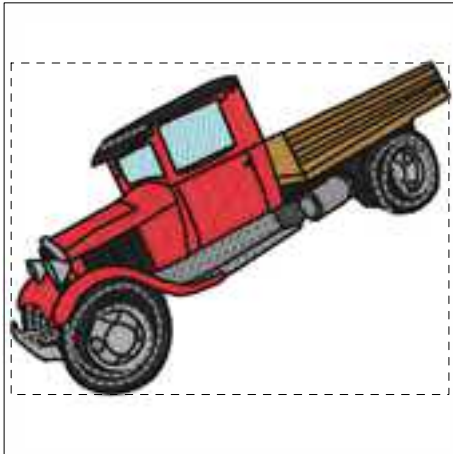

- 1. Light Blue (Bro:17)
- 2. Dark Gray (Bro:707)
- 3. Gray (Bro:817)
- 4. Silver (Bro:5)
- 5. Light Brown (Bro:323)
- 6. Red (Bro:800)
- 7. Black (Bro:900)
- 8. Gray (Bro:817)

Eo701-01-4x4.pes

3.81x2.89 inches; 14,823 stitches
8 thread changes; 7 colors

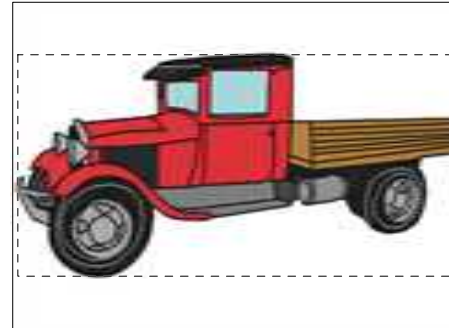

- 1. Light Blue (Bro:17)
- 2. Dark Gray (Bro:707)
- 3. Gray (Bro:817)
- 4. Silver (Bro:5)
- 5. Light Brown (Bro:323)
- 6. Red (Bro:800)
- 7. Black (Bro:900)
- 8. Gray (Bro:817)

Eo701-01-5x7.pes

6.93x3.48 inches; 30,403 stitches
8 thread changes; 7 colors

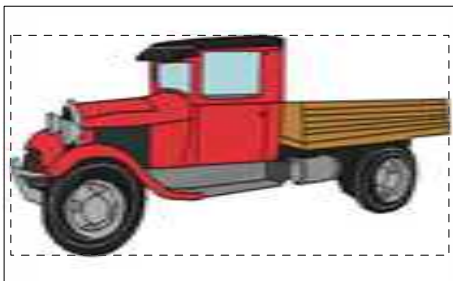

- 1. Light Blue (Bro:17)
- 2. Dark Gray (Bro:707)
- 3. Gray (Bro:817)
- 4. Silver (Bro:5)
- 5. Light Brown (Bro:323)
- 6. Red (Bro:800)
- 7. Black (Bro:900)
- 8. Gray (Bro:817)

Eo701-01-6x10.pes

9.93x4.98 inches; 49,233 stitches
8 thread changes; 7 colors

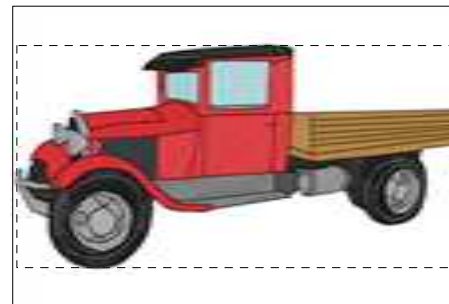

- 1. Light Blue (Bro:17)
- 2. Dark Gray (Bro:707)
- 3. Gray (Bro:817)
- 4. Silver (Bro:5)
- 5. Light Brown (Bro:323)
- 6. Red (Bro:800)
- 7. Black (Bro:900)
- 8. Gray (Bro:817)

Eo701-01-8x12.pes

11.59x5.81 inches; 61,780 stitches
8 thread changes; 7 colors

Printed 12/5/2018

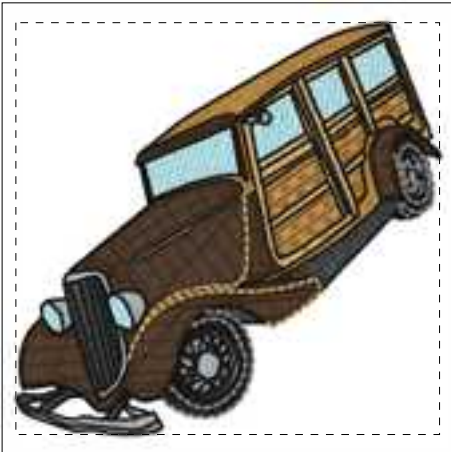

- 1. Silver (Bro:5)
- 2. Dark Gray (Bro:707)
- 3. Gray (Bro:817)
- 4. Light Blue (Bro:17)
- 5. Dark Brown (Bro:58)
- 6. Light Brown (Bro:323)
- 7. Khaki (Bro:348)
- 8. Black (Bro:900)
- 9. Gray (Bro:817)
- 10. Khaki (Bro:348)

Eo701-02-4x4.pes

3.69x3.59 inches; 20,872 stitches
10 thread changes; 8 colors

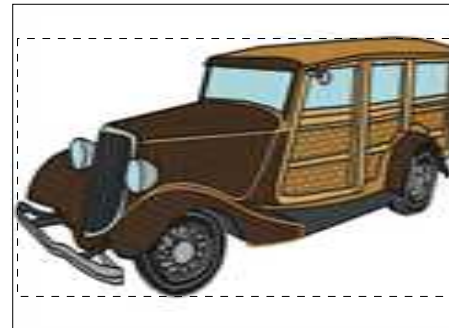

- 1. Silver (Bro:5)
- 2. Dark Gray (Bro:707)
- 3. Gray (Bro:817)
- 4. Light Blue (Bro:17)
- 5. Dark Brown (Bro:58)
- 6. Light Brown (Bro:323)
- 7. Khaki (Bro:348)
- 8. Black (Bro:900)
- 9. Gray (Bro:817)
- 10. Khaki (Bro:348)

Eo701-02-5x7.pes

6.93x4.05 inches; 43,075 stitches
10 thread changes; 8 colors

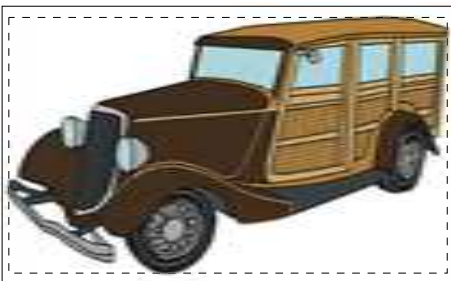

- 1. Silver (Bro:5)
- 2. Dark Gray (Bro:707)
- 3. Gray (Bro:817)
- 4. Light Blue (Bro:17)
- 5. Dark Brown (Bro:58)
- 6. Light Brown (Bro:323)
- 7. Khaki (Bro:348)
- 8. Black (Bro:900)
- 9. Gray (Bro:817)
- 10. Khaki (Bro:348)

Eo701-02-6x10.pes

9.94x5.80 inches; 70,527 stitches
10 thread changes; 8 colors

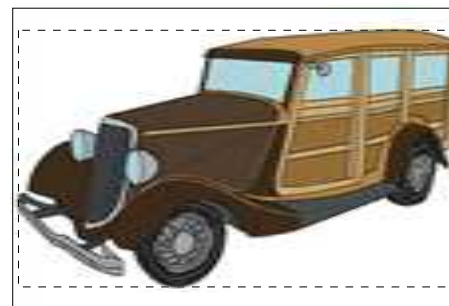

- 1. Silver (Bro:5)
- 2. Dark Gray (Bro:707)
- 3. Gray (Bro:817)
- 4. Light Blue (Bro:17)
- 5. Dark Brown (Bro:58)
- 6. Light Brown (Bro:323)
- 7. Khaki (Bro:348)
- 8. Black (Bro:900)
- 9. Gray (Bro:817)
- 10. Khaki (Bro:348)

Eo701-02-8x12.pes

11.51x6.71 inches; 87,089 stitches
10 thread changes; 8 colors

Printed 12/5/2018

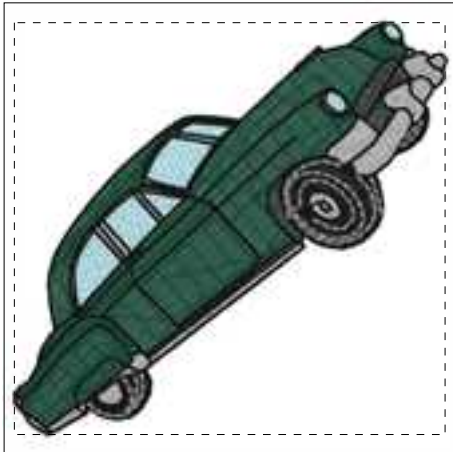

- 1. Light Blue (Bro:17)
- 2. Red (Bro:800)
- 3. Silver (Bro:5)
- 4. Dark Gray (Bro:707)
- 5. Deep Green (Bro:808)
- 6. Black (Bro:900)
- 7. Gray (Bro:817)

Eo701-03-4x4.pes

3.75x3.59 inches; 13,010 stitches
7 thread changes; 7 colors

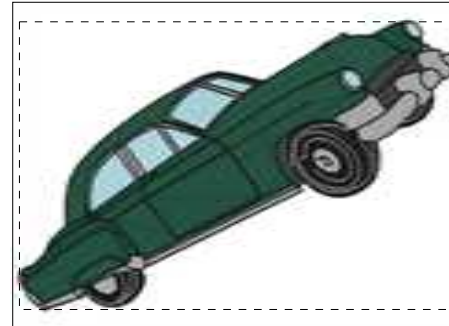

- 1. Light Blue (Bro:17)
- 2. Red (Bro:800)
- 3. Silver (Bro:5)
- 4. Dark Gray (Bro:707)
- 5. Deep Green (Bro:808)
- 6. Black (Bro:900)
- 7. Gray (Bro:817)

Eo701-03-5x7.pes

6.87x4.52 inches; 27,283 stitches
7 thread changes; 7 colors

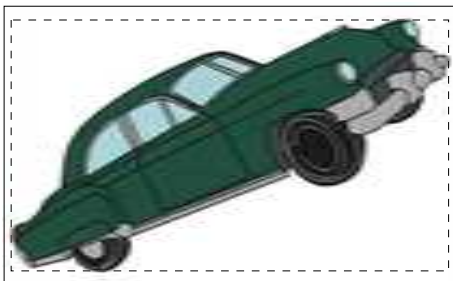

- 1. Light Blue (Bro:17)
- 2. Red (Bro:800)
- 3. Silver (Bro:5)
- 4. Dark Gray (Bro:707)
- 5. Deep Green (Bro:808)
- 6. Black (Bro:900)
- 7. Gray (Bro:817)

Eo701-03-6x10.pes

9.91x5.68 inches; 48,359 stitches
7 thread changes; 7 colors

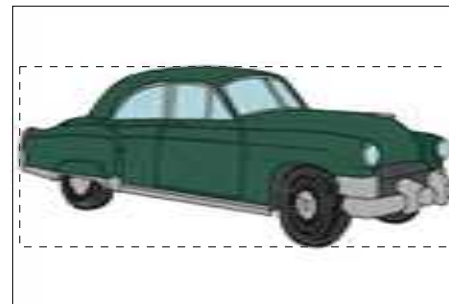

- 1. Light Blue (Bro:17)
- 2. Red (Bro:800)
- 3. Silver (Bro:5)
- 4. Dark Gray (Bro:707)
- 5. Deep Green (Bro:808)
- 6. Black (Bro:900)
- 7. Gray (Bro:817)

Eo701-03-8x12.pes

11.44x4.71 inches; 54,641 stitches
7 thread changes; 7 colors

Printed 12/5/2018

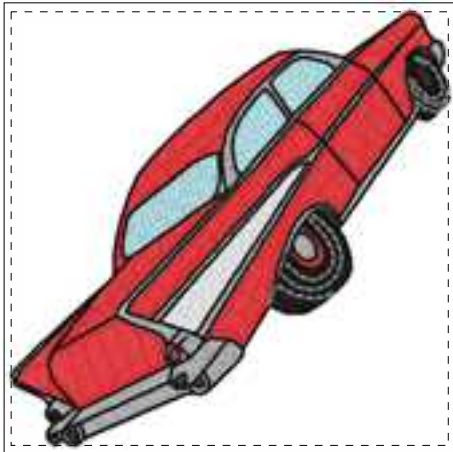

- 1. Light Blue (Bro:17)
- 2. Red (Bro:800)
- 3. White (Bro:1)
- 4. Dark Gray (Bro:707)
- 5. Silver (Bro:5)
- 6. Black (Bro:900)
- 7. Gray (Bro:817)

Eo701-04-4x4.pes

3.81x3.78 inches; 13,659 stitches
7 thread changes; 7 colors

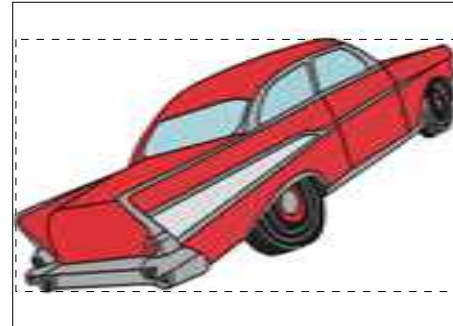

- 1. Light Blue (Bro:17)
- 2. Red (Bro:800)
- 3. White (Bro:1)
- 4. Dark Gray (Bro:707)
- 5. Silver (Bro:5)
- 6. Black (Bro:900)
- 7. Gray (Bro:817)

Eo701-04-5x7.pes

6.99x3.95 inches; 29,252 stitches
7 thread changes; 7 colors

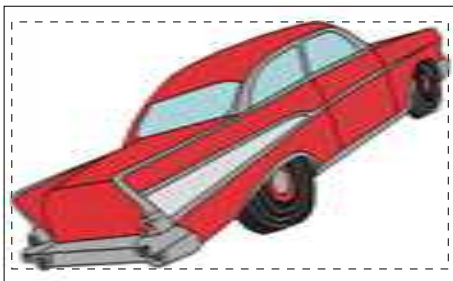

- 1. Light Blue (Bro:17)
- 2. Red (Bro:800)
- 3. White (Bro:1)
- 4. Dark Gray (Bro:707)
- 5. Silver (Bro:5)
- 6. Black (Bro:900)
- 7. Gray (Bro:817)

Eo701-04-6x10.pes

9.89x5.59 inches; 47,816 stitches
7 thread changes; 7 colors

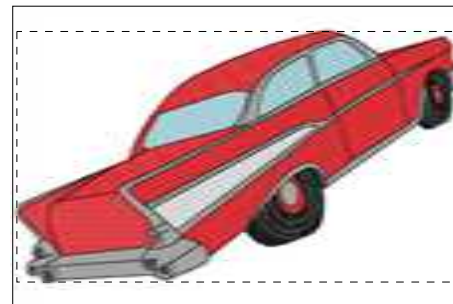

- 1. Light Blue (Bro:17)
- 2. Red (Bro:800)
- 3. White (Bro:1)
- 4. Dark Gray (Bro:707)
- 5. Silver (Bro:5)
- 6. Black (Bro:900)
- 7. Gray (Bro:817)

Eo701-04-8x12.pes

11.59x6.56 inches; 60,846 stitches
7 thread changes; 7 colors

Printed 12/5/2018

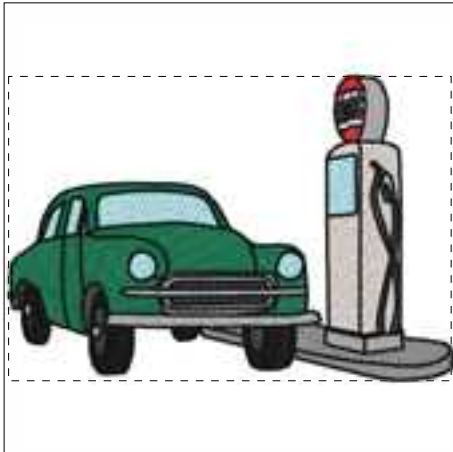

- 1. Light Blue (Bro:17)
- 2. Emerald Green (Bro:507)
- 3. Gray (Bro:817)
- 4. Silver (Bro:5)
- 5. Dark Gray (Bro:707)
- 6. Warm Gray (Bro:399)
- 7. Red (Bro:800)
- 8. White (Bro:1)
- 9. Black (Bro:900)

Eo701-05-4x4.pes

3.85x2.65 inches; 16,412 stitches
9 thread changes; 9 colors



- 1. Light Blue (Bro:17)
- 2. Emerald Green (Bro:507)
- 3. Gray (Bro:817)
- 4. Silver (Bro:5)
- 5. Dark Gray (Bro:707)
- 6. Warm Gray (Bro:399)
- 7. Red (Bro:800)
- 8. White (Bro:1)
- 9. Black (Bro:900)

Eo701-05-5x7.pes

6.93x4.76 inches; 33,552 stitches
9 thread changes; 9 colors



- 1. Light Blue (Bro:17)
- 2. Emerald Green (Bro:507)
- 3. Gray (Bro:817)
- 4. Silver (Bro:5)
- 5. Dark Gray (Bro:707)
- 6. Warm Gray (Bro:399)
- 7. Red (Bro:800)
- 8. White (Bro:1)
- 9. Black (Bro:900)

Eo701-05-6x10.pes

9.91x5.96 inches; 45,560 stitches
9 thread changes; 9 colors

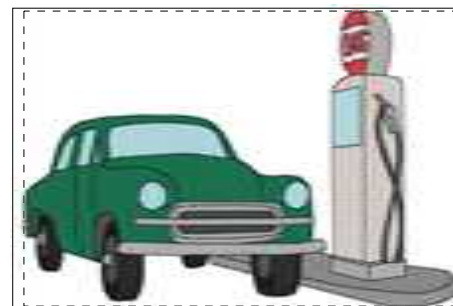

- 1. Light Blue (Bro:17)
- 2. Emerald Green (Bro:507)
- 3. Gray (Bro:817)
- 4. Silver (Bro:5)
- 5. Dark Gray (Bro:707)
- 6. Warm Gray (Bro:399)
- 7. Red (Bro:800)
- 8. White (Bro:1)
- 9. Black (Bro:900)

Eo701-05-8x12.pes

11.24x7.72 inches; 66,232 stitches
9 thread changes; 9 colors

Printed 12/5/2018

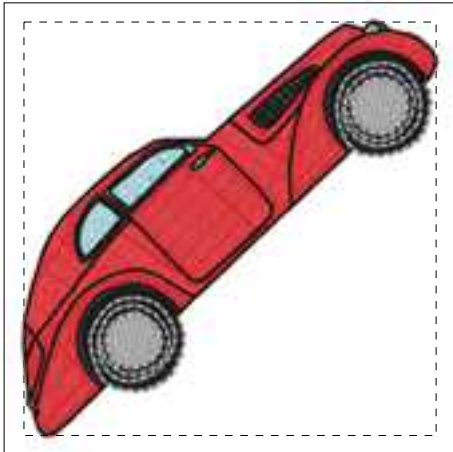

- 1. Dark Gray (Bro:707)
- 2. Light Blue (Bro:17)
- 3. Red (Bro:800)
- 4. Silver (Bro:5)
- 5. Black (Bro:900)
- 6. Silver (Bro:5)

Eo701-06-4x4.pes

3.59x3.60 inches; 11,539 stitches
6 thread changes; 5 colors

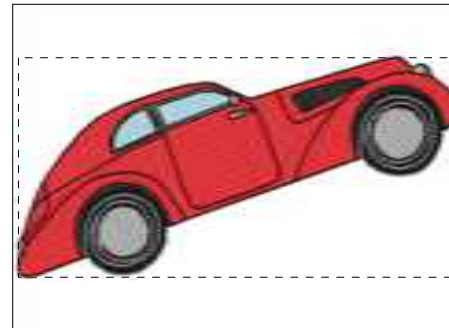

- 1. Dark Gray (Bro:707)
- 2. Light Blue (Bro:17)
- 3. Red (Bro:800)
- 4. Silver (Bro:5)
- 5. Black (Bro:900)
- 6. Silver (Bro:5)

Eo701-06-5x7.pes

6.91x3.44 inches; 24,095 stitches
6 thread changes; 5 colors

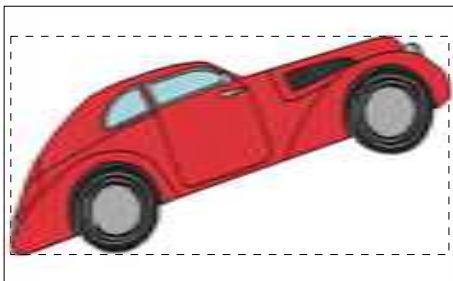

- 1. Dark Gray (Bro:707)
- 2. Light Blue (Bro:17)
- 3. Red (Bro:800)
- 4. Silver (Bro:5)
- 5. Black (Bro:900)
- 6. Silver (Bro:5)

Eo701-06-6x10.pes

9.93x4.95 inches; 40,898 stitches
6 thread changes; 5 colors

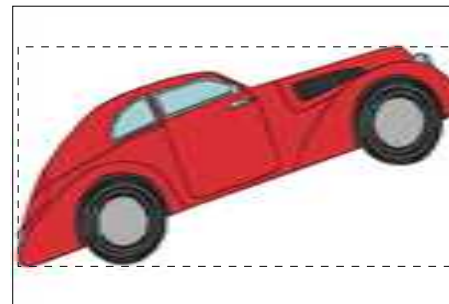

- 1. Dark Gray (Bro:707)
- 2. Light Blue (Bro:17)
- 3. Red (Bro:800)
- 4. Silver (Bro:5)
- 5. Black (Bro:900)
- 6. Silver (Bro:5)

Eo701-06-8x12.pes

11.53x5.74 inches; 51,341 stitches
6 thread changes; 5 colors

Printed 12/5/2018

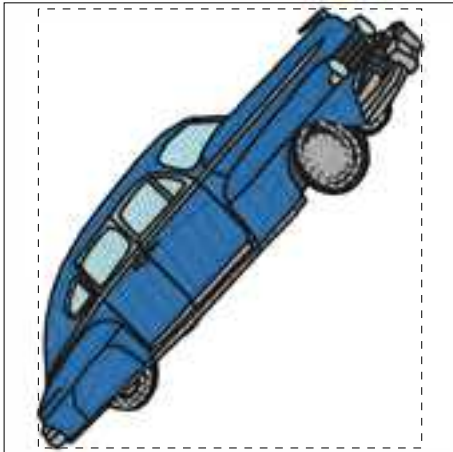

- 1. Dark Gray (Bro:707)
- 2. Light Blue (Bro:17)
- 3. Electric Blue (Bro:420)
- 4. Silver (Bro:5)
- 5. Black (Bro:900)
- 6. Silver (Bro:5)

Eo701-07-4x4.pes

3.34x3.82 inches; 13,695 stitches
6 thread changes; 5 colors

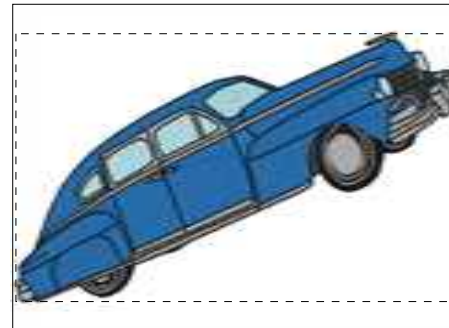

- 1. Dark Gray (Bro:707)
- 2. Light Blue (Bro:17)
- 3. Electric Blue (Bro:420)
- 4. Silver (Bro:5)
- 5. Black (Bro:900)
- 6. Silver (Bro:5)

Eo701-07-5x7.pes

6.98x4.20 inches; 28,841 stitches
6 thread changes; 5 colors

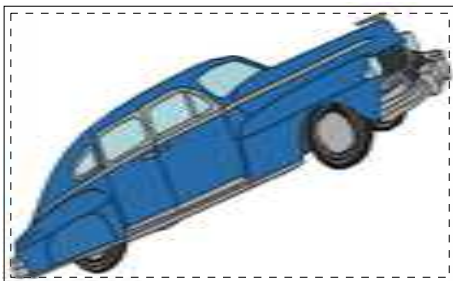

- 1. Dark Gray (Bro:707)
- 2. Light Blue (Bro:17)
- 3. Electric Blue (Bro:420)
- 4. Silver (Bro:5)
- 5. Black (Bro:900)
- 6. Silver (Bro:5)

Eo701-07-6x10.pes

9.94x5.98 inches; 46,965 stitches
6 thread changes; 5 colors

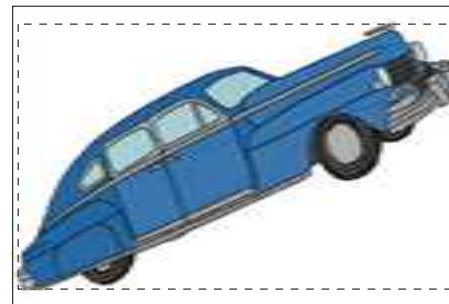

- 1. Dark Gray (Bro:707)
- 2. Light Blue (Bro:17)
- 3. Electric Blue (Bro:420)
- 4. Silver (Bro:5)
- 5. Black (Bro:900)
- 6. Silver (Bro:5)

Eo701-07-8x12.pes

11.52x6.93 inches; 58,341 stitches
6 thread changes; 5 colors

Printed 12/5/2018

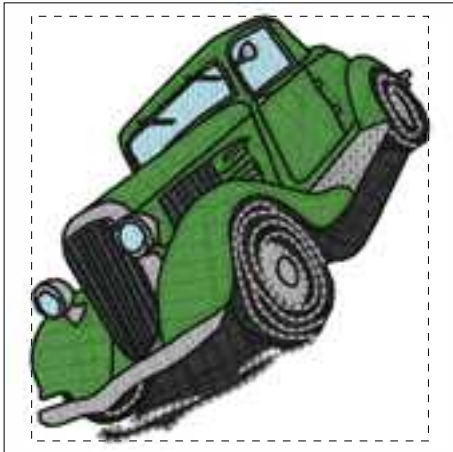

- 1. Light Blue (Bro:17)
- 2. Moss Green (Bro:515)
- 3. Dark Gray (Bro:707)
- 4. Silver (Bro:5)
- 5. Black (Bro:900)
- 6. Silver (Bro:5)

Eo701-08-4x4.pes

3.46x3.70 inches; 19,425 stitches
6 thread changes; 5 colors

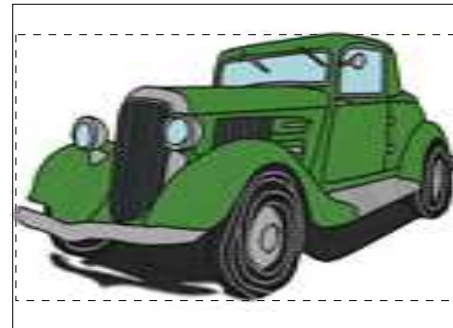

- 1. Light Blue (Bro:17)
- 2. Moss Green (Bro:515)
- 3. Dark Gray (Bro:707)
- 4. Silver (Bro:5)
- 5. Black (Bro:900)
- 6. Silver (Bro:5)

Eo701-08-5x7.pes

6.99x4.17 inches; 41,412 stitches
6 thread changes; 5 colors

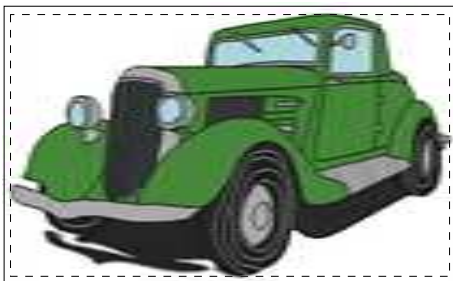

- 1. Light Blue (Bro:17)
- 2. Moss Green (Bro:515)
- 3. Dark Gray (Bro:707)
- 4. Silver (Bro:5)
- 5. Black (Bro:900)
- 6. Silver (Bro:5)

Eo701-08-6x10.pes

9.95x5.93 inches; 68,219 stitches
6 thread changes; 5 colors

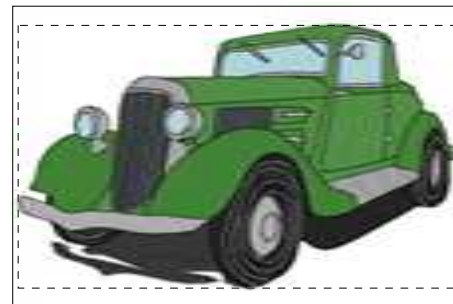

- 1. Light Blue (Bro:17)
- 2. Moss Green (Bro:515)
- 3. Dark Gray (Bro:707)
- 4. Silver (Bro:5)
- 5. Black (Bro:900)
- 6. Silver (Bro:5)

Eo701-08-8x12.pes

11.53x6.87 inches; 85,132 stitches
6 thread changes; 5 colors

Printed 12/5/2018

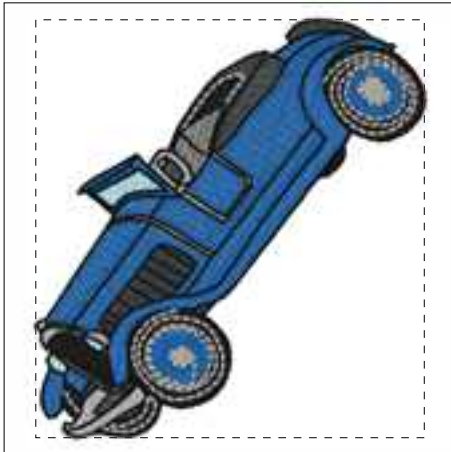

- 1. Dark Gray (Bro:707)
- 2. Gray (Bro:817)
- 3. Light Blue (Bro:17)
- 4. Blue (Bro:405)
- 5. Silver (Bro:5)
- 6. Black (Bro:900)
- 7. Silver (Bro:5)

Eo701-09-4x4.pes

3.39x3.64 inches; 16,686 stitches
7 thread changes; 6 colors

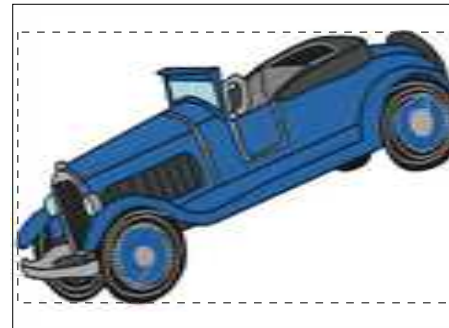

- 1. Dark Gray (Bro:707)
- 2. Gray (Bro:817)
- 3. Light Blue (Bro:17)
- 4. Blue (Bro:405)
- 5. Silver (Bro:5)
- 6. Black (Bro:900)
- 7. Silver (Bro:5)

Eo701-09-5x7.pes

6.93x4.25 inches; 34,781 stitches
7 thread changes; 6 colors

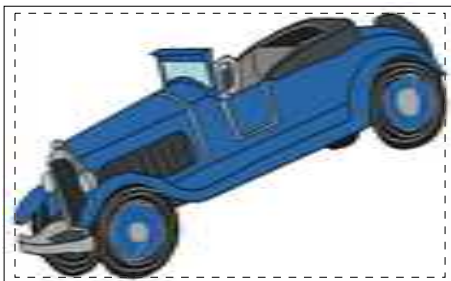

- 1. Dark Gray (Bro:707)
- 2. Gray (Bro:817)
- 3. Light Blue (Bro:17)
- 4. Blue (Bro:405)
- 5. Silver (Bro:5)
- 6. Black (Bro:900)
- 7. Silver (Bro:5)

Eo701-09-6x10.pes

9.74x5.98 inches; 56,419 stitches
7 thread changes; 6 colors

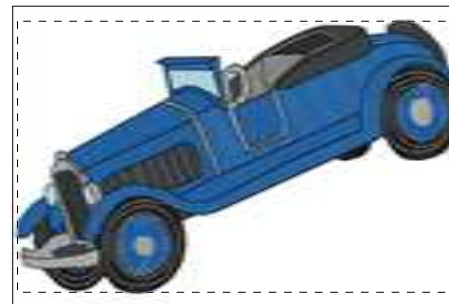

- 1. Dark Gray (Bro:707)
- 2. Gray (Bro:817)
- 3. Light Blue (Bro:17)
- 4. Blue (Bro:405)
- 5. Silver (Bro:5)
- 6. Black (Bro:900)
- 7. Silver (Bro:5)

Eo701-09-8x12.pes

11.56x7.09 inches; 73,318 stitches
7 thread changes; 6 colors

Printed 12/5/2018

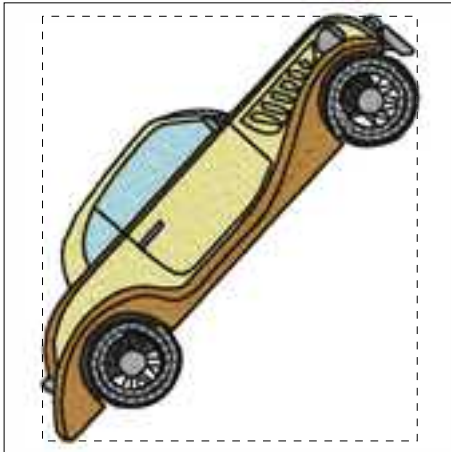

- 1. Dark Gray (Bro:707)
- 2. Light Blue (Bro:17)
- 3. Cream Yellow (Bro:812)
- 4. Light Brown (Bro:323)
- 5. Silver (Bro:5)
- 6. Black (Bro:900)
- 7. Silver (Bro:5)

Eo701-10-4x4.pes

3.26x3.70 inches; 14,025 stitches
7 thread changes; 6 colors

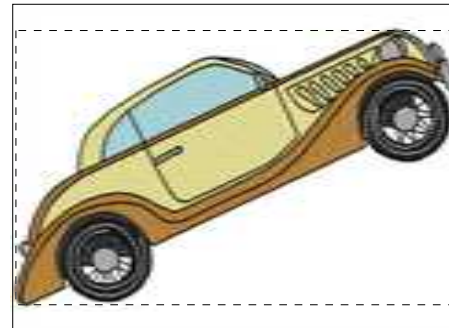

- 1. Dark Gray (Bro:707)
- 2. Light Blue (Bro:17)
- 3. Cream Yellow (Bro:812)
- 4. Light Brown (Bro:323)
- 5. Silver (Bro:5)
- 6. Black (Bro:900)
- 7. Silver (Bro:5)

Eo701-10-5x7.pes

6.98x4.30 inches; 30,833 stitches
7 thread changes; 6 colors

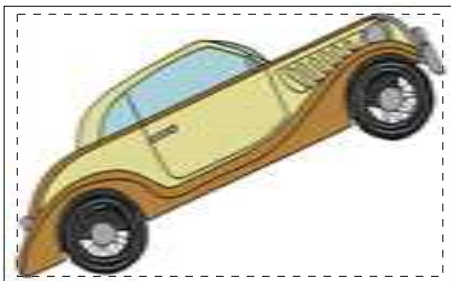

- 1. Dark Gray (Bro:707)
- 2. Light Blue (Bro:17)
- 3. Cream Yellow (Bro:812)
- 4. Light Brown (Bro:323)
- 5. Silver (Bro:5)
- 6. Black (Bro:900)
- 7. Silver (Bro:5)

Eo701-10-6x10.pes

9.64x5.94 inches; 48,978 stitches
7 thread changes; 6 colors

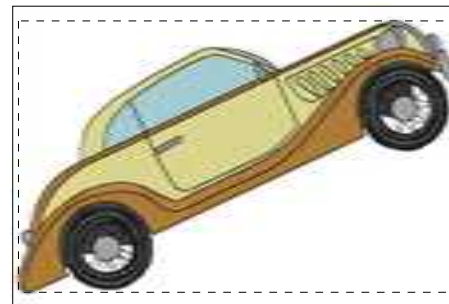

- 1. Dark Gray (Bro:707)
- 2. Light Blue (Bro:17)
- 3. Cream Yellow (Bro:812)
- 4. Light Brown (Bro:323)
- 5. Silver (Bro:5)
- 6. Black (Bro:900)
- 7. Silver (Bro:5)

Eo701-10-8x12.pes

11.52x7.09 inches; 63,424 stitches
7 thread changes; 6 colors

Printed 12/5/2018

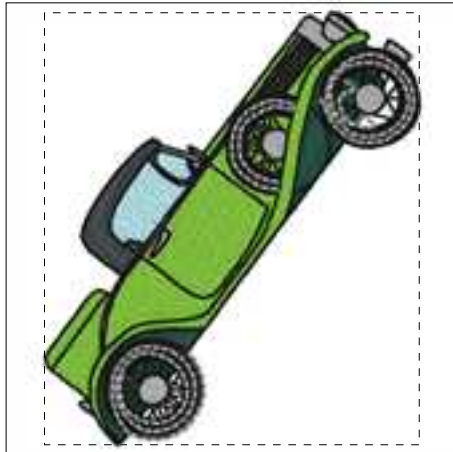

- 1. Light Blue (Bro:17)
- 2. Lime Green (Bro:513)
- 3. Deep Green (Bro:808)
- 4. Silver (Bro:5)
- 5. Dark Gray (Bro:707)
- 6. Black (Bro:900)
- 7. Silver (Bro:5)

Eo701-11-4x4.pes

3.26x3.76 inches; 15,777 stitches
7 thread changes; 6 colors

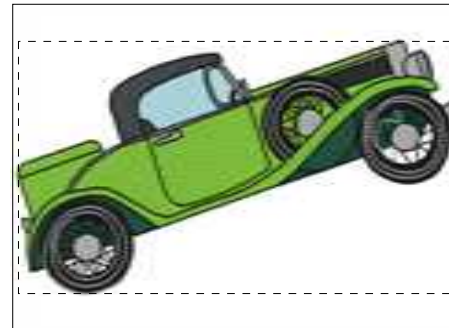

- 1. Light Blue (Bro:17)
- 2. Lime Green (Bro:513)
- 3. Deep Green (Bro:808)
- 4. Silver (Bro:5)
- 5. Dark Gray (Bro:707)
- 6. Black (Bro:900)
- 7. Silver (Bro:5)

Eo701-11-5x7.pes

6.90x3.96 inches; 32,654 stitches
7 thread changes; 6 colors

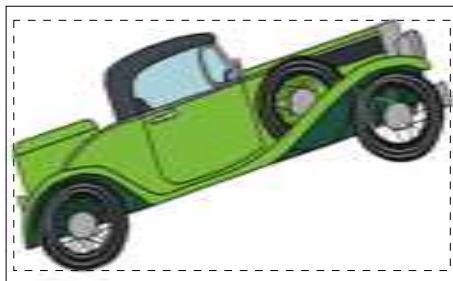

- 1. Light Blue (Bro:17)
- 2. Lime Green (Bro:513)
- 3. Deep Green (Bro:808)
- 4. Silver (Bro:5)
- 5. Dark Gray (Bro:707)
- 6. Black (Bro:900)
- 7. Silver (Bro:5)

Eo701-11-6x10.pes

9.89x5.67 inches; 52,756 stitches
7 thread changes; 6 colors

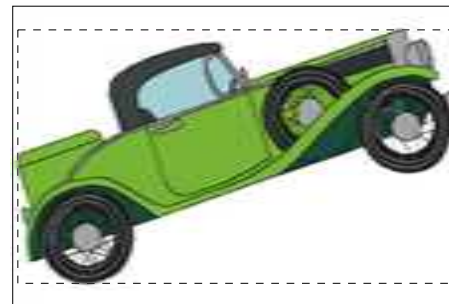

- 1. Light Blue (Bro:17)
- 2. Lime Green (Bro:513)
- 3. Deep Green (Bro:808)
- 4. Silver (Bro:5)
- 5. Dark Gray (Bro:707)
- 6. Black (Bro:900)
- 7. Silver (Bro:5)

Eo701-11-8x12.pes

11.55x6.63 inches; 66,269 stitches
7 thread changes; 6 colors

Printed 12/5/2018

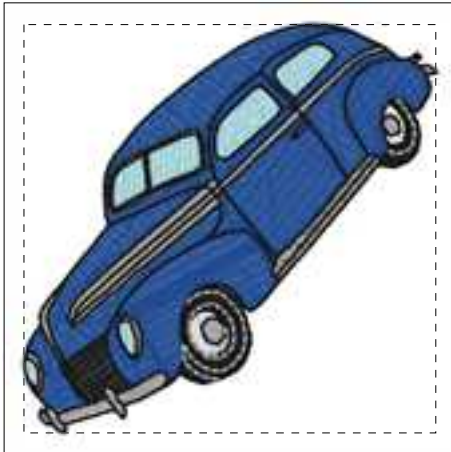

- 1. Dark Gray (Bro:707)
- 2. Light Blue (Bro:17)
- 3. Ultramarine (Bro:406)
- 4. Silver (Bro:5)
- 5. White (Bro:1)
- 6. Red (Bro:800)
- 7. Black (Bro:900)
- 8. Silver (Bro:5)

Eo701-12-4x4.pes

3.59x3.56 inches; 16,296 stitches
8 thread changes; 7 colors

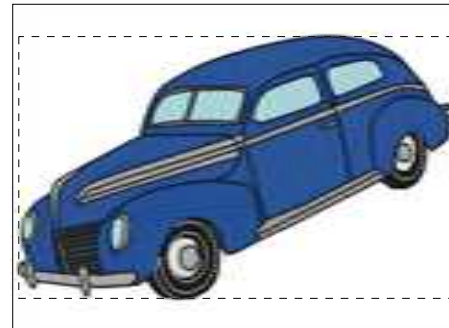

- 1. Dark Gray (Bro:707)
- 2. Light Blue (Bro:17)
- 3. Ultramarine (Bro:406)
- 4. Silver (Bro:5)
- 5. White (Bro:1)
- 6. Red (Bro:800)
- 7. Black (Bro:900)
- 8. Silver (Bro:5)

Eo701-12-5x7.pes

6.90x4.11 inches; 33,837 stitches
8 thread changes; 7 colors

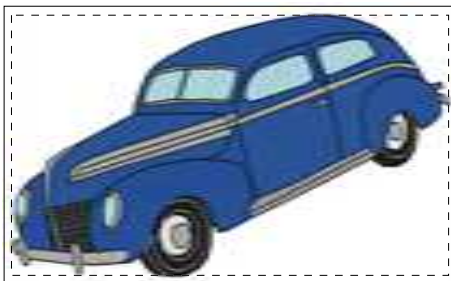

- 1. Dark Gray (Bro:707)
- 2. Light Blue (Bro:17)
- 3. Ultramarine (Bro:406)
- 4. Silver (Bro:5)
- 5. White (Bro:1)
- 6. Red (Bro:800)
- 7. Black (Bro:900)
- 8. Silver (Bro:5)

Eo701-12-6x10.pes

9.91x5.90 inches; 56,610 stitches
8 thread changes; 7 colors

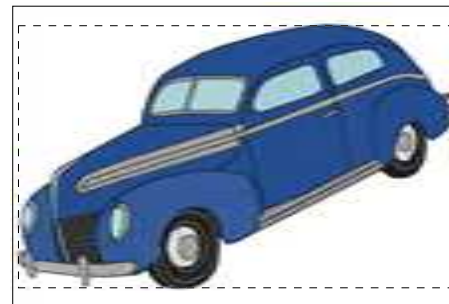

- 1. Dark Gray (Bro:707)
- 2. Light Blue (Bro:17)
- 3. Ultramarine (Bro:406)
- 4. Silver (Bro:5)
- 5. White (Bro:1)
- 6. Red (Bro:800)
- 7. Black (Bro:900)
- 8. Silver (Bro:5)

Eo701-12-8x12.pes

11.52x6.85 inches; 70,974 stitches
8 thread changes; 7 colors

Printed 12/5/2018



- 1. Light Blue (Bro:17)
- 2. Dark Gray (Bro:707)
- 3. Silver (Bro:5)
- 4. Gray (Bro:817)
- 5. Black (Bro:900)
- 6. Silver (Bro:5)

Eo701-13-4x4.pes

3.50x3.67 inches; 18,418 stitches
6 thread changes; 5 colors

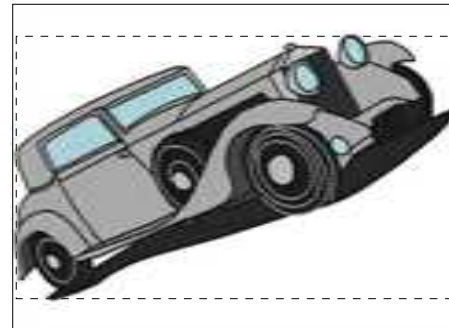

- 1. Light Blue (Bro:17)
- 2. Dark Gray (Bro:707)
- 3. Silver (Bro:5)
- 4. Gray (Bro:817)
- 5. Black (Bro:900)
- 6. Silver (Bro:5)

Eo701-13-5x7.pes

6.98x4.12 inches; 37,533 stitches
6 thread changes; 5 colors

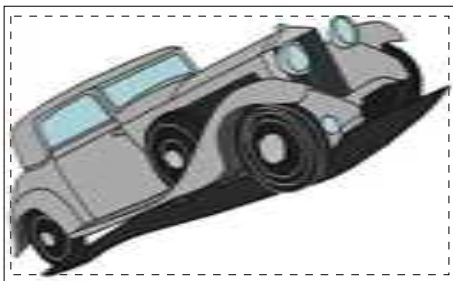

- 1. Light Blue (Bro:17)
- 2. Dark Gray (Bro:707)
- 3. Silver (Bro:5)
- 4. Gray (Bro:817)
- 5. Black (Bro:900)
- 6. Silver (Bro:5)

Eo701-13-6x10.pes

9.93x5.86 inches; 61,135 stitches
6 thread changes; 5 colors

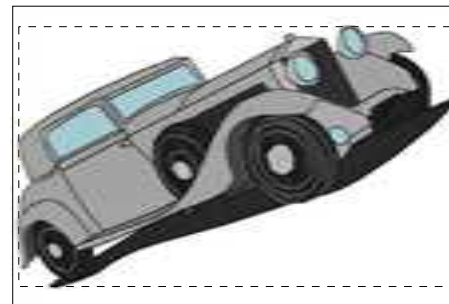

- 1. Light Blue (Bro:17)
- 2. Dark Gray (Bro:707)
- 3. Silver (Bro:5)
- 4. Gray (Bro:817)
- 5. Black (Bro:900)
- 6. Silver (Bro:5)

Eo701-13-8x12.pes

11.50x6.80 inches; 75,443 stitches
6 thread changes; 5 colors

Printed 12/5/2018

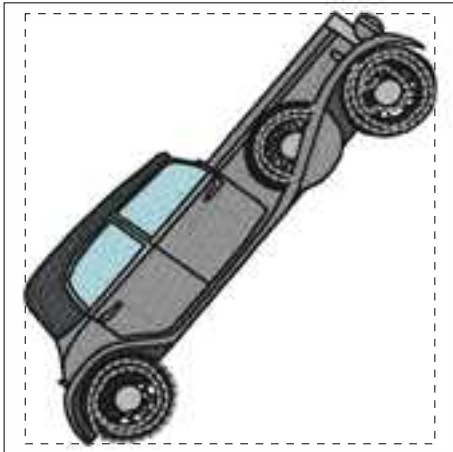

- 1. Light Blue (Bro:17)
- 2. Dark Gray (Bro:707)
- 3. Gray (Bro:817)
- 4. Silver (Bro:5)
- 5. Black (Bro:900)
- 6. Silver (Bro:5)

Eo701-14-4x4.pes

3.57x3.75 inches; 15,628 stitches
6 thread changes; 5 colors

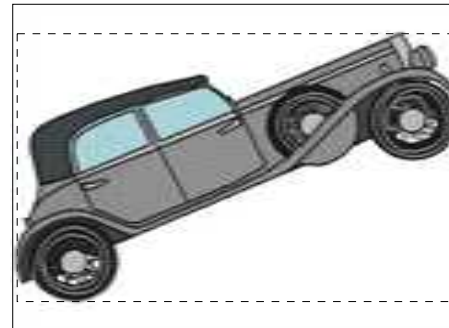

- 1. Light Blue (Bro:17)
- 2. Dark Gray (Bro:707)
- 3. Gray (Bro:817)
- 4. Silver (Bro:5)
- 5. Black (Bro:900)
- 6. Silver (Bro:5)

Eo701-14-5x7.pes

6.94x4.20 inches; 31,280 stitches
6 thread changes; 5 colors

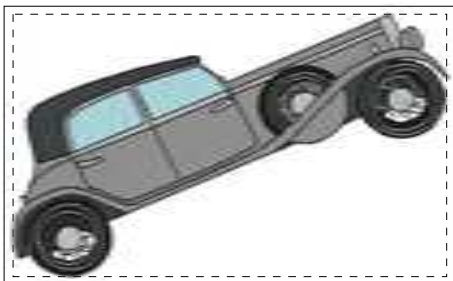

- 1. Light Blue (Bro:17)
- 2. Dark Gray (Bro:707)
- 3. Gray (Bro:817)
- 4. Silver (Bro:5)
- 5. Black (Bro:900)
- 6. Silver (Bro:5)

Eo701-14-6x10.pes

9.82x5.94 inches; 50,139 stitches
6 thread changes; 5 colors

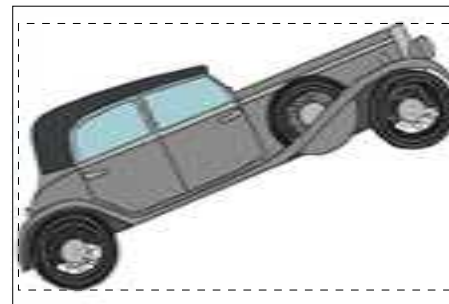

- 1. Light Blue (Bro:17)
- 2. Dark Gray (Bro:707)
- 3. Gray (Bro:817)
- 4. Silver (Bro:5)
- 5. Black (Bro:900)
- 6. Silver (Bro:5)

Eo701-14-8x12.pes

11.52x6.97 inches; 62,973 stitches
6 thread changes; 5 colors

Printed 12/5/2018

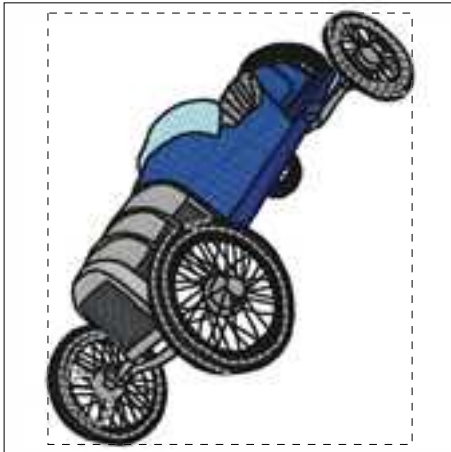

- 1. Light Blue (Bro:17)
- 2. Dark Gray (Bro:707)
- 3. Light Brown (Bro:323)
- 4. Silver (Bro:5)
- 5. Black (Bro:900)
- 6. Ultramarine (Bro:406)
- 7. Prussian Blue (Bro:7)
- 8. Black (Bro:900)
- 9. Silver (Bro:5)

Eo701-15-4x4.pes

3.17x3.76 inches; 17,413 stitches
9 thread changes; 7 colors

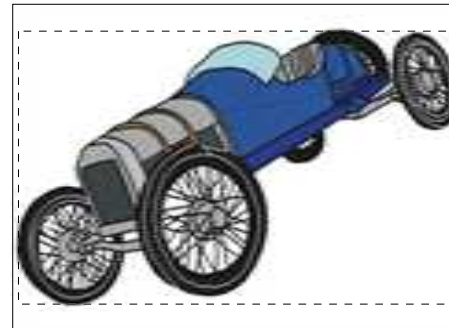

- 1. Light Blue (Bro:17)
- 2. Dark Gray (Bro:707)
- 3. Light Brown (Bro:323)
- 4. Silver (Bro:5)
- 5. Black (Bro:900)
- 6. Ultramarine (Bro:406)
- 7. Prussian Blue (Bro:7)
- 8. Black (Bro:900)
- 9. Silver (Bro:5)

Eo701-15-5x7.pes

6.90x4.28 inches; 34,117 stitches
9 thread changes; 7 colors

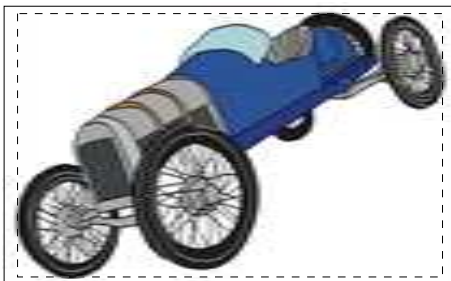

- 1. Light Blue (Bro:17)
- 2. Dark Gray (Bro:707)
- 3. Light Brown (Bro:323)
- 4. Silver (Bro:5)
- 5. Black (Bro:900)
- 6. Ultramarine (Bro:406)
- 7. Prussian Blue (Bro:7)
- 8. Black (Bro:900)
- 9. Silver (Bro:5)

Eo701-15-6x10.pes

9.62x5.97 inches; 52,809 stitches
9 thread changes; 7 colors

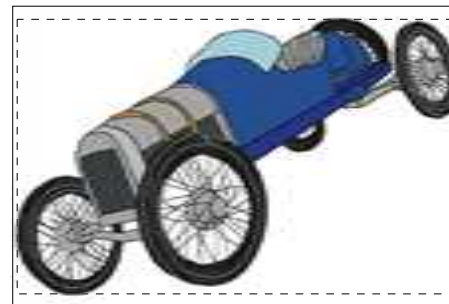

- 1. Light Blue (Bro:17)
- 2. Dark Gray (Bro:707)
- 3. Light Brown (Bro:323)
- 4. Silver (Bro:5)
- 5. Black (Bro:900)
- 6. Ultramarine (Bro:406)
- 7. Prussian Blue (Bro:7)
- 8. Black (Bro:900)
- 9. Silver (Bro:5)

Eo701-15-8x12.pes

11.57x7.18 inches; 67,707 stitches
9 thread changes; 7 colors

Printed 12/5/2018

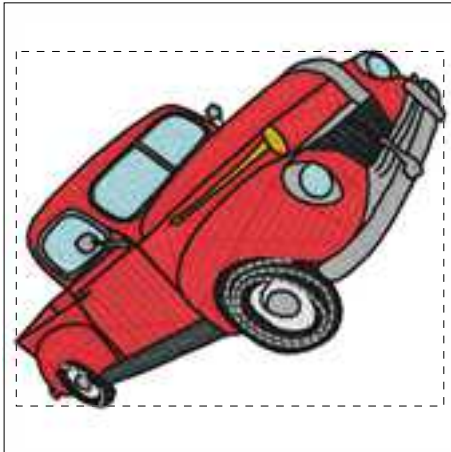

- 1. Light Blue (Bro:17)
- 2. Red (Bro:800)
- 3. Dark Gray (Bro:707)
- 4. Deep Gold (Bro:214)
- 5. Silver (Bro:5)
- 6. White (Bro:1)
- 7. Black (Bro:900)
- 8. Silver (Bro:5)

Eo701-16-4x4.pes

3.72x3.09 inches; 17,158 stitches
8 thread changes; 7 colors

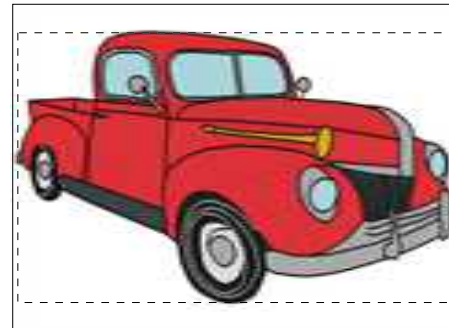

- 1. Light Blue (Bro:17)
- 2. Red (Bro:800)
- 3. Dark Gray (Bro:707)
- 4. Deep Gold (Bro:214)
- 5. Silver (Bro:5)
- 6. White (Bro:1)
- 7. Black (Bro:900)
- 8. Silver (Bro:5)

Eo701-16-5x7.pes

6.93x4.23 inches; 36,914 stitches
8 thread changes; 7 colors

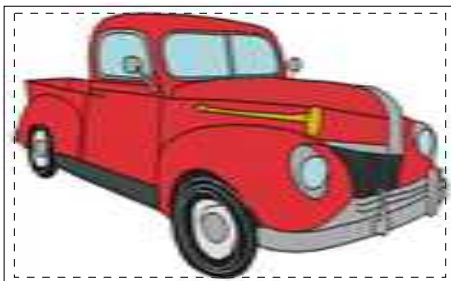

- 1. Light Blue (Bro:17)
- 2. Red (Bro:800)
- 3. Dark Gray (Bro:707)
- 4. Deep Gold (Bro:214)
- 5. Silver (Bro:5)
- 6. White (Bro:1)
- 7. Black (Bro:900)
- 8. Silver (Bro:5)

Eo701-16-6x10.pes

9.78x5.98 inches; 60,282 stitches
8 thread changes; 7 colors

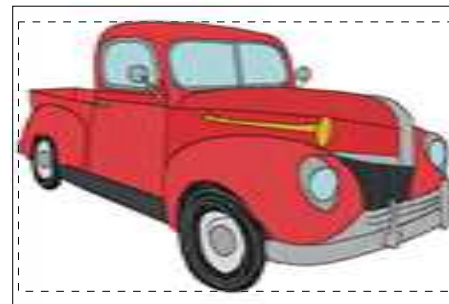

- 1. Light Blue (Bro:17)
- 2. Red (Bro:800)
- 3. Dark Gray (Bro:707)
- 4. Deep Gold (Bro:214)
- 5. Silver (Bro:5)
- 6. White (Bro:1)
- 7. Black (Bro:900)
- 8. Silver (Bro:5)

Eo701-16-8x12.pes

11.52x7.04 inches; 77,053 stitches
8 thread changes; 7 colors