

Enjoy this fun set of shoes. These sew out very quickly in Bean Stitch. These would be really pretty in varigated or metallic threads. This set would be great on any project, especially on shopping bags.

E:\00 SWAK EMBROIDERY FILES\EO321 and EO322 These shoes-boots are made for walking\EO322.These.Shoes.Are.Made.for.Walking.pes

Printed 2/4/2020

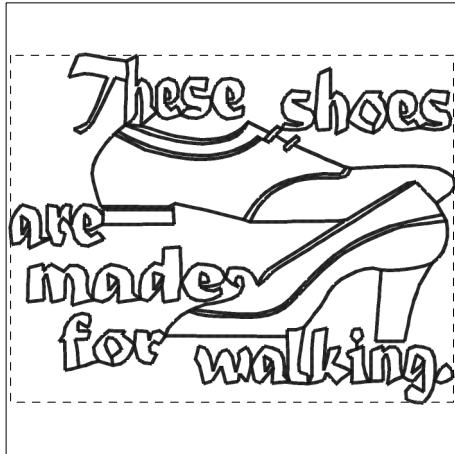

■ 1. Black

01 4x4.pes

3.86x3.02 inches; 4,618 stitches
1 thread changes; 1 colors

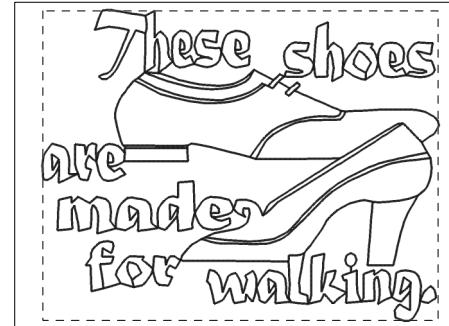

■ 1. Black

01 5x7.pes

6.20x4.85 inches; 7,020 stitches
1 thread changes; 1 colors

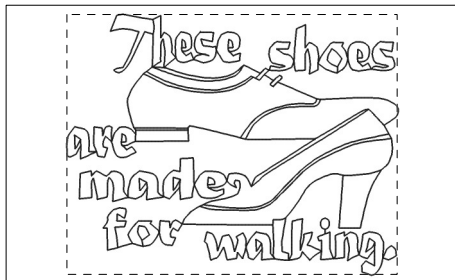

■ 1. Black

01 6x10.pes

7.48x5.89 inches; 8,390 stitches
1 thread changes; 1 colors

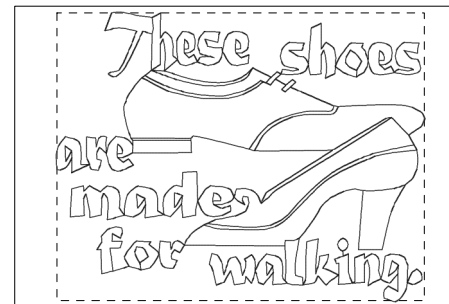

■ 1. Black (Bro:900)

01 8x12.pes

9.60x7.53 inches; 10,556 stitches
1 thread changes; 1 colors

Enjoy this fun set of shoes. These sew out very quickly in Bean Stitch. These would be really pretty in vairaged or metallic threads. This set would be great on any project, especially on shopping bags.

E:\00 SWAK EMBROIDERY FILES\EO321 and EO322 These shoes-boots are made for walking\EO322.These.Shoes.Are.Made.for.Walking.pes

Printed 2/4/2020

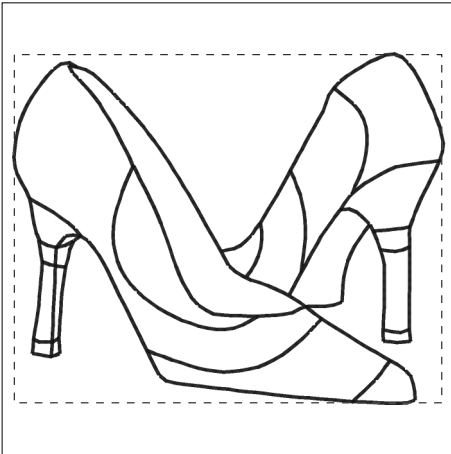

■ 1. Black

02 4x4.pes

3.72x3.03 inches; 1,918 stitches
1 thread changes; 1 colors

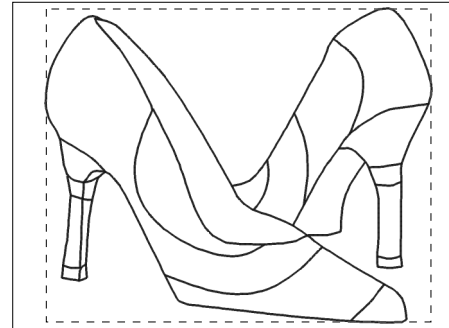

■ 1. Black

02 5x7.pes

6.04x4.91 inches; 3,034 stitches
1 thread changes; 1 colors

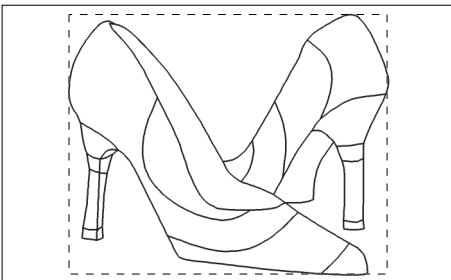

■ 1. Black

02 6x10.pes

7.21x5.87 inches; 3,602 stitches
1 thread changes; 1 colors

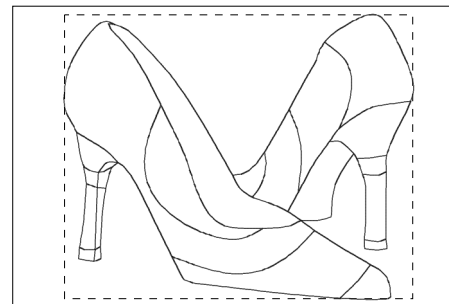

■ 1. Black (Bro:900)

02 8x12.pes

9.11x7.42 inches; 4,530 stitches
1 thread changes; 1 colors

Enjoy this fun set of shoes. These sew out very quickly in Bean Stitch. These would be really pretty in vairaged or metallic threads. This set would be great on any project, especially on shopping bags.

E:\00 SWAK EMBROIDERY FILES\EO321 and EO322 These shoes-boots are made for walking\EO322.These.Shoes.Are.Made.for.Walking.pes

Printed 2/4/2020



■ 1. Black

03 4x4.pes

3.80x3.30 inches; 3,686 stitches
1 thread changes; 1 colors

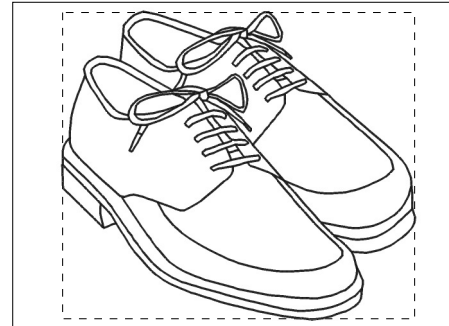

■ 1. Black

03 5x7.pes

5.52x4.81 inches; 5,199 stitches
1 thread changes; 1 colors

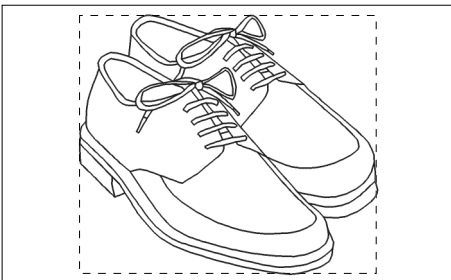

■ 1. Black

03 6x10.pes

6.72x5.84 inches; 6,302 stitches
1 thread changes; 1 colors

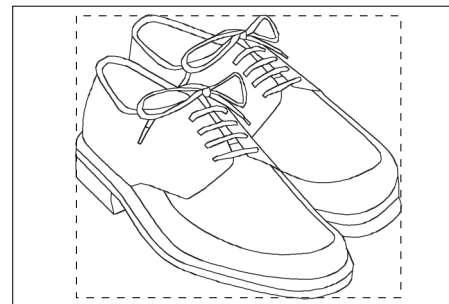

■ 1. Black (Bro:900)

03 8x12.pes

8.48x7.38 inches; 7,837 stitches
1 thread changes; 1 colors

Enjoy this fun set of shoes. These sew out very quickly in Bean Stitch. These would be really pretty in vairaged or metallic threads. This set would be great on any project, especially on shopping bags.

E:\00 SWAK EMBROIDERY FILES\EO321 and EO322 These shoes-boots are made for walking\EO322.These.Shoes.Are.Made.for.Walking.pes

Printed 2/4/2020

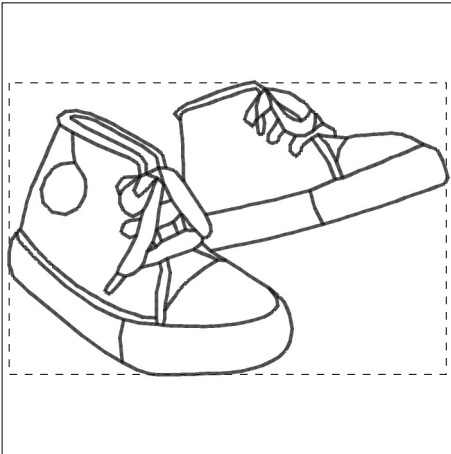

■ 1. Black

04 4x4.pes

3.81x2.54 inches; 1,270 stitches
1 thread changes; 1 colors

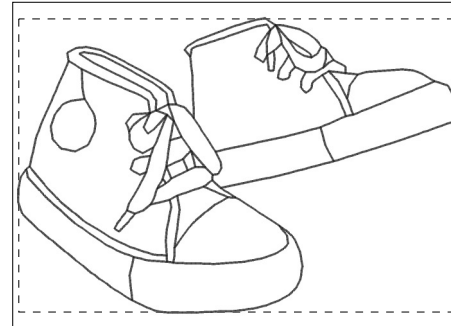

■ 1. Black

04 5x7.pes

6.89x4.60 inches; 2,114 stitches
1 thread changes; 1 colors

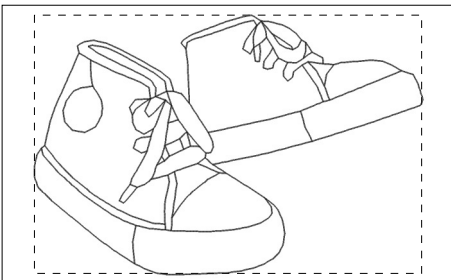

■ 1. Black

04 6x10.pes

8.77x5.85 inches; 2,594 stitches
1 thread changes; 1 colors

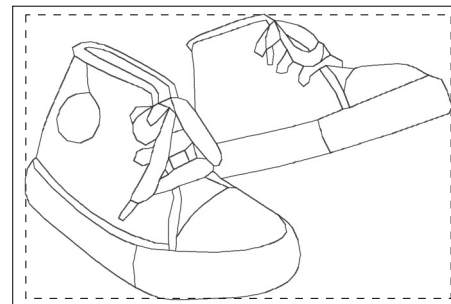

■ 1. Black (Bro:900)

04 8x12.pes

11.12x7.41 inches; 3,224 stitches
1 thread changes; 1 colors

Enjoy this fun set of shoes. These sew out very quickly in Bean Stitch. These would be really pretty in vairaged or metallic threads. This set would be great on any project, especially on shopping bags.

E:\00 SWAK EMBROIDERY FILES\EO321 and EO322 These shoes-boots are made for walking\EO322.These.Shoes.Are.Made.for.Walking.pes

Printed 2/4/2020

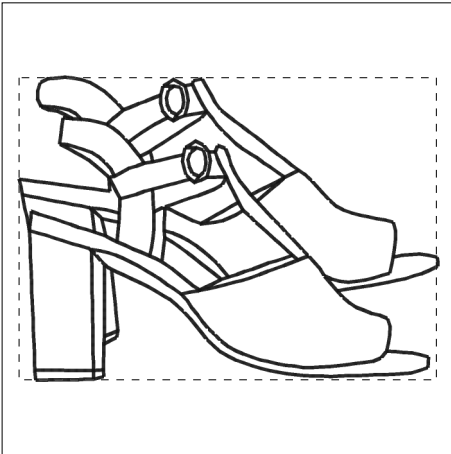

■ 1. Black

05 4x4.pes

3.63x2.63 inches; 2,566 stitches
1 thread changes; 1 colors

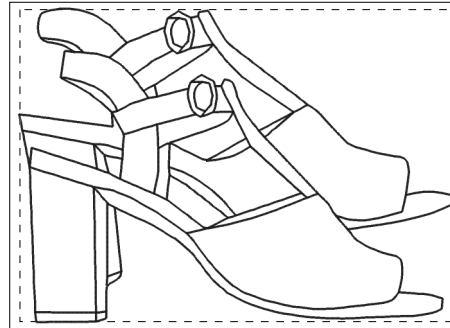

■ 1. Black

05 5x7.pes

6.77x4.89 inches; 4,538 stitches
1 thread changes; 1 colors

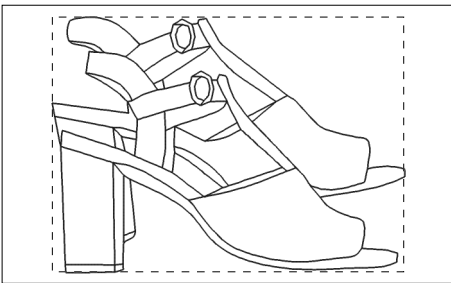

■ 1. Black

05 6x10.pes

7.96x5.77 inches; 5,326 stitches
1 thread changes; 1 colors

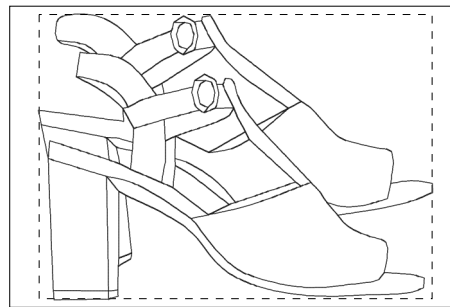

■ 1. Black (Bro:900)

05 8x12.pes

10.27x7.43 inches; 6,778 stitches
1 thread changes; 1 colors

Enjoy this fun set of shoes. These sew out very quickly in Bean Stitch. These would be really pretty in vairaged or metalic threads. This set would be great on any project, especially on shopping bags.

E:\00 SWAK EMBROIDERY FILES\EO321 and EO322 These shoes-boots are made for walking\EO322.These.Shoes.Are.Made.for.Walking.pes

Printed 2/4/2020

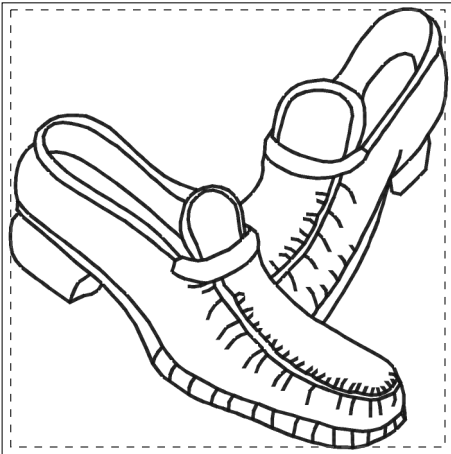

■ 1. Black

06 4x4.pes

3.78x3.81 inches; 3,290 stitches
1 thread changes; 1 colors

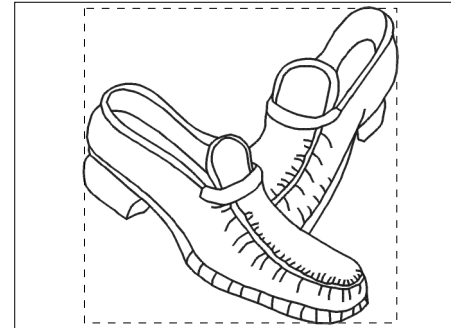

■ 1. Black

06 5x7.pes

4.91x4.93 inches; 4,226 stitches
1 thread changes; 1 colors

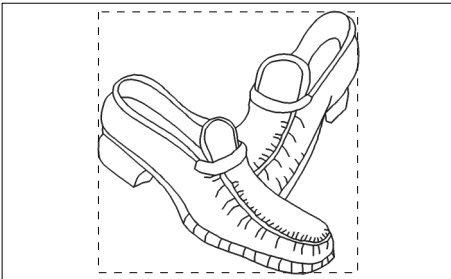

■ 1. Black

06 6x10.pes

5.88x5.91 inches; 4,930 stitches
1 thread changes; 1 colors

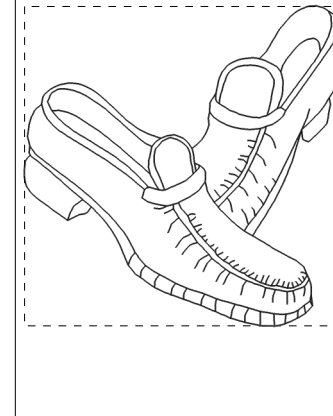

■ 1. Black (Bro:900)

06 8x12.pes

7.44x7.48 inches; 6,082 stitches
1 thread changes; 1 colors

Enjoy this fun set of shoes. These sew out very quickly in Bean Stitch. These would be really pretty in vairaged or metallic threads. This set would be great on any project, especially on shopping bags.

E:\00 SWAK EMBROIDERY FILES\EO321 and EO322 These shoes-boots are made for walking\EO322.These.Shoes.Are.Made.for.Walking.pes

Printed 2/4/2020

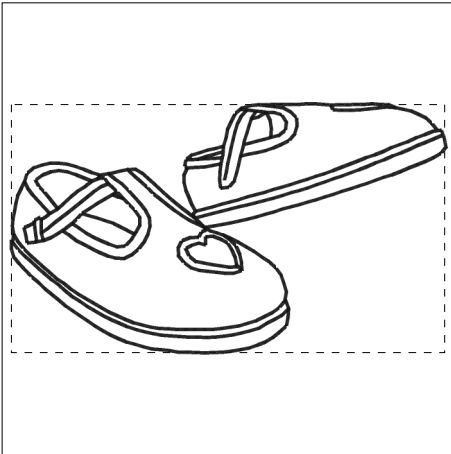

■ 1. Black

07 4x4.pes

3.77x2.16 inches; 2,134 stitches
1 thread changes; 1 colors

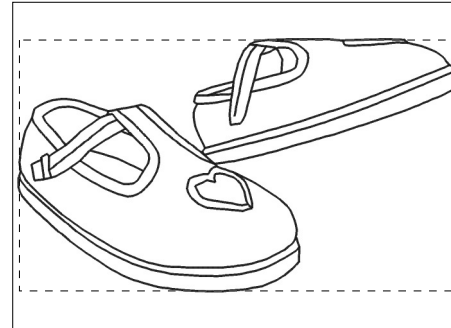

■ 1. Black

07 5x7.pes

6.88x3.94 inches; 3,742 stitches
1 thread changes; 1 colors

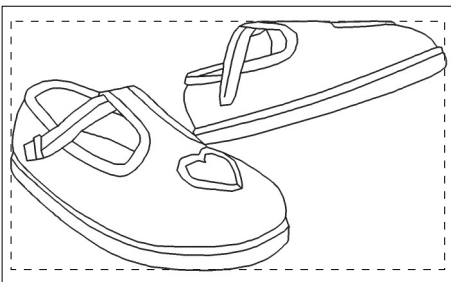

■ 1. Black

07 6x10.pes

9.82x5.63 inches; 5,270 stitches
1 thread changes; 1 colors

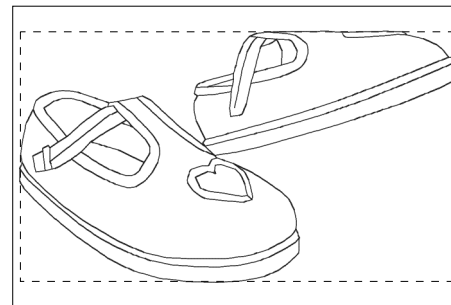

■ 1. Black (Bro:900)

07 8x12.pes

11.41x6.53 inches; 6,106 stitches
1 thread changes; 1 colors

Enjoy this fun set of shoes. These sew out very quickly in Bean Stitch. These would be really pretty in vairaged or metallic threads. This set would be great on any project, especially on shopping bags.

E:\00 SWAK EMBROIDERY FILES\EO321 and EO322 These shoes-boots are made for walking\EO322.These.Shoes.Are.Made.for.Walking.pes

Printed 2/4/2020

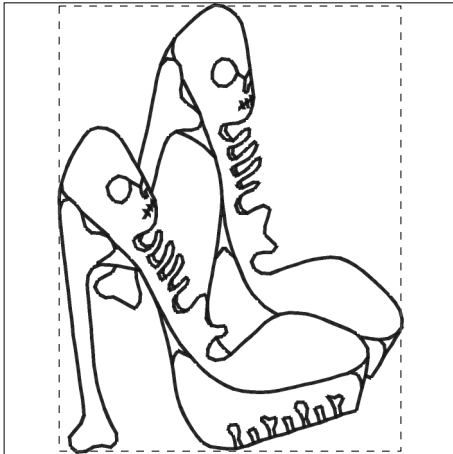

■ 1. Black

08 4x4.pes

2.98x3.88 inches; 2,606 stitches
1 thread changes; 1 colors

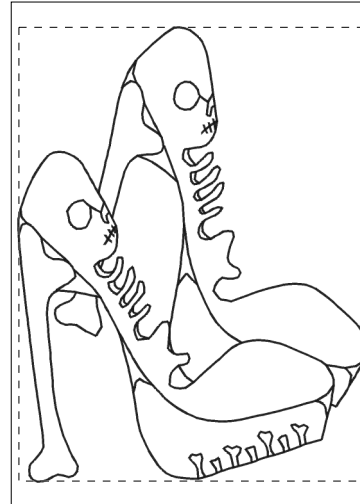

■ 1. Black

08 5x7.pes

4.90x6.37 inches; 4,026 stitches
1 thread changes; 1 colors

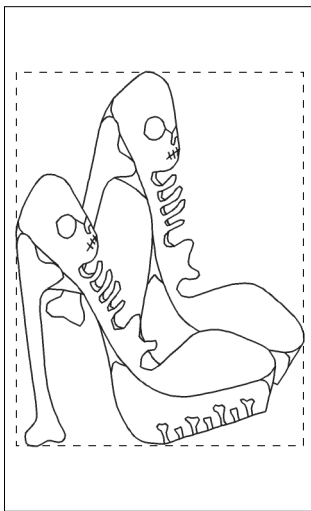

■ 1. Black

08 6x10.pes

5.82x7.57 inches; 4,750 stitches
1 thread changes; 1 colors

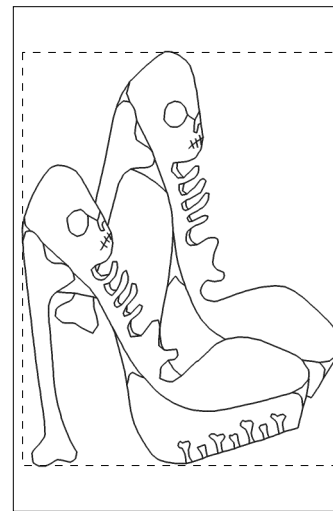

■ 1. Black (Bro:900)

08 8x12.pes

7.44x9.67 inches; 5,998 stitches
1 thread changes; 1 colors

Enjoy this fun set of shoes. These sew out very quickly in Bean Stitch. These would be really pretty in vairaged or metallic threads. This set would be great on any project, especially on shopping bags.

E:\00 SWAK EMBROIDERY FILES\EO321 and EO322 These shoes-boots are made for walking\EO322.These.Shoes.Are.Made.for.Walking.pes

Printed 2/4/2020



■ 1. Black

09 4x4.pes

3.74x2.57 inches; 3,634 stitches
1 thread changes; 1 colors

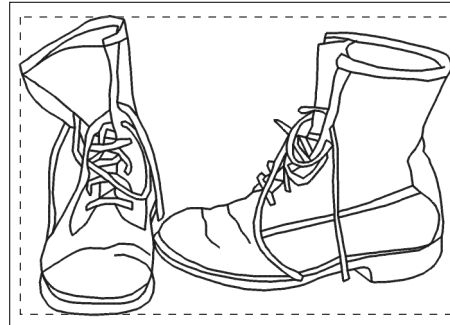

■ 1. Black

09 5x7.pes

6.75x4.67 inches; 6,278 stitches
1 thread changes; 1 colors

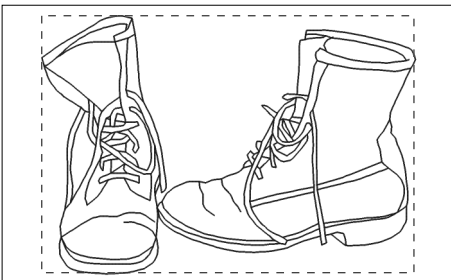

■ 1. Black

09 6x10.pes

8.43x5.82 inches; 7,734 stitches
1 thread changes; 1 colors

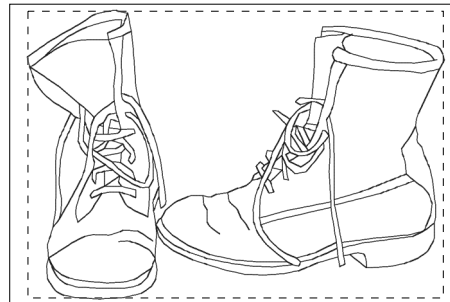

■ 1. Black (Bro:900)

09 8x12.pes

10.87x7.50 inches; 9,810 stitches
1 thread changes; 1 colors

Enjoy this fun set of shoes. These sew out very quickly in Bean Stitch. These would be really pretty in vairaged or metallic threads. This set would be great on any project, especially on shopping bags.

E:\00 SWAK EMBROIDERY FILES\EO321 and EO322 These shoes-boots are made for walking\EO322.These.Shoes.Are.Made.for.Walking.pes

Printed 2/4/2020



■ 1. Black (Bro:900)

10 4x4.pes

3.77x2.99 inches; 4,424 stitches
1 thread changes; 1 colors



■ 1. Black (Bro:900)

10 5x7.pes

6.12x4.84 inches; 6,764 stitches
1 thread changes; 1 colors

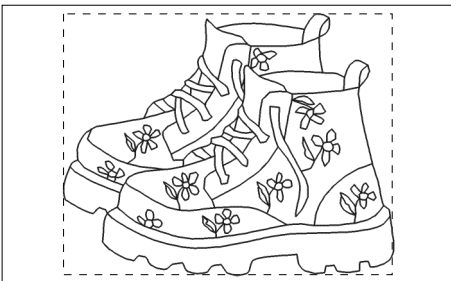

■ 1. Black (Bro:900)

10 6x10.pes

7.44x5.91 inches; 8,112 stitches
1 thread changes; 1 colors

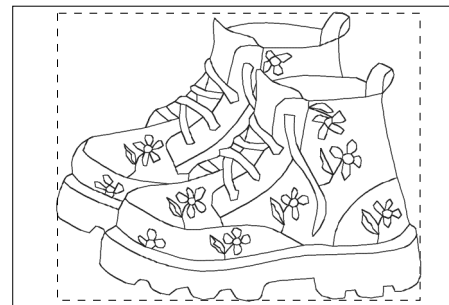

■ 1. Black (Bro:900)

10 8x12.pes

9.48x7.51 inches; 10,152 stitches
1 thread changes; 1 colors

Enjoy this fun set of shoes. These sew out very quickly in Bean Stitch. These would be really pretty in vairaged or metallic threads. This set would be great on any project, especially on shopping bags.

E:\00 SWAK EMBROIDERY FILES\EO321 and EO322 These shoes-boots are made for walking\EO322.These.Shoes.Are.Made.for.Walking.pes

Printed 2/4/2020

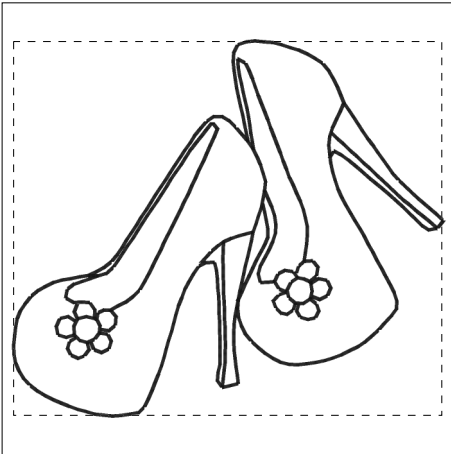

■ 1. Black

11 4x4.pes

3.73x3.26 inches; 1,922 stitches
1 thread changes; 1 colors

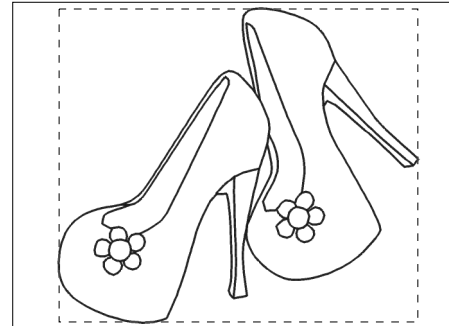

■ 1. Black

11 5x7.pes

5.63x4.91 inches; 2,870 stitches
1 thread changes; 1 colors

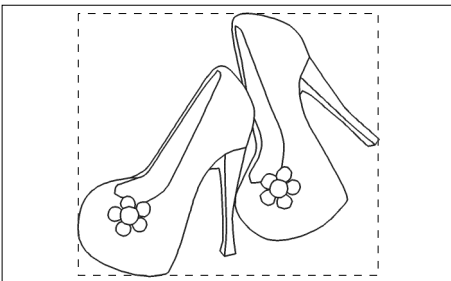

■ 1. Black

11 6x10.pes

6.80x5.93 inches; 3,438 stitches
1 thread changes; 1 colors

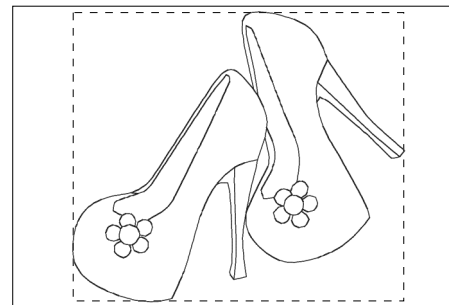

■ 1. Black (Bro:900)

11 8x12.pes

8.64x7.54 inches; 4,342 stitches
1 thread changes; 1 colors

Enjoy this fun set of shoes. These sew out very quickly in Bean Stitch. These would be really pretty in vairaged or metallic threads. This set would be great on any project, especially on shopping bags.

E:\00 SWAK EMBROIDERY FILES\EO321 and EO322 These shoes-boots are made for walking\EO322.These.Shoes.Are.Made.for.Walking.pes

Printed 2/4/2020

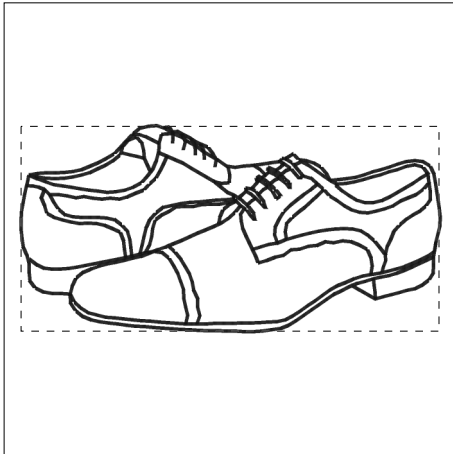

■ 1. Black

12 4x4.pes

3.64x1.79 inches; 2,430 stitches
1 thread changes; 1 colors

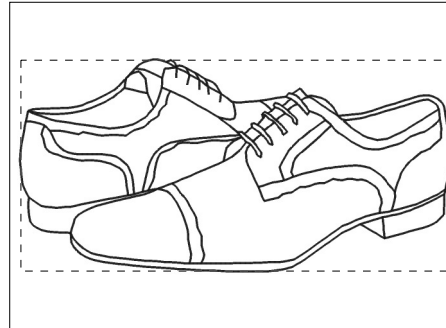

■ 1. Black

12 5x7.pes

6.74x3.31 inches; 4,266 stitches
1 thread changes; 1 colors

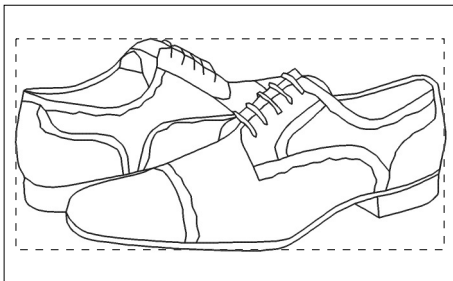

■ 1. Black

12 6x10.pes

9.70x4.78 inches; 6,018 stitches
1 thread changes; 1 colors

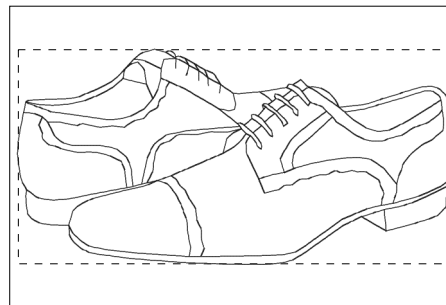

■ 1. Black (Bro:900)

12 8x12.pes

11.36x5.60 inches; 7,010 stitches
1 thread changes; 1 colors

Enjoy this fun set of shoes. These sew out very quickly in Bean Stitch. These would be really pretty in vairaged or metallic threads. This set would be great on any project, especially on shopping bags.

E:\00 SWAK EMBROIDERY FILES\EO321 and EO322 These shoes-boots are made for walking\EO322.These.Shoes.Are.Made.for.Walking.pes

Printed 2/4/2020



■ 1. Black

13 4x4.pes

3.76x2.77 inches; 3,130 stitches
1 thread changes; 1 colors

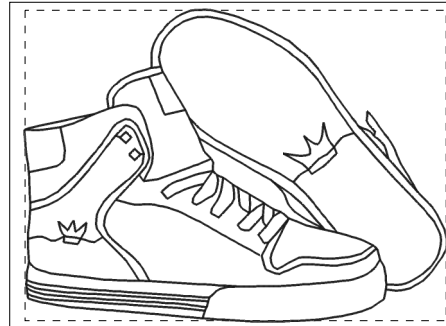

■ 1. Black

13 5x7.pes

6.61x4.87 inches; 5,350 stitches
1 thread changes; 1 colors

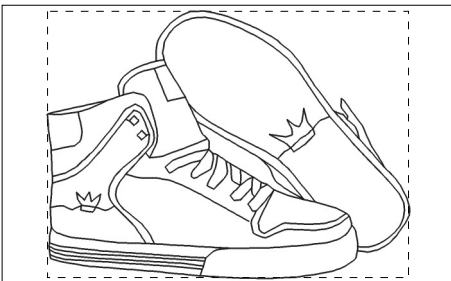

■ 1. Black

13 6x10.pes

8.18x6.03 inches; 6,548 stitches
1 thread changes; 1 colors

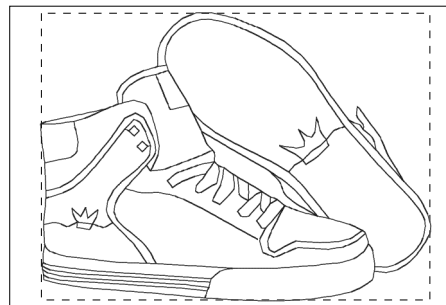

■ 1. Black (Bro:900)

13 8x12.pes

10.17x7.49 inches; 8,074 stitches
1 thread changes; 1 colors

Enjoy this fun set of shoes. These sew out very quickly in Bean Stitch. These would be really pretty in vairaged or metallic threads. This set would be great on any project, especially on shopping bags.

E:\00 SWAK EMBROIDERY FILES\EO321 and EO322 These shoes-boots are made for walking\EO322.These.Shoes.Are.Made.for.Walking.pes

Printed 2/4/2020

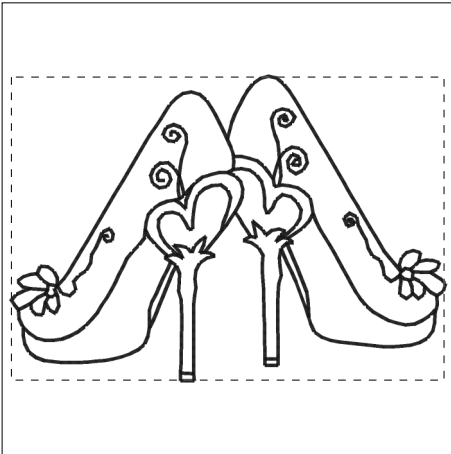

■ 1. Black

14 4x4.pes

3.77x2.64 inches; 2,346 stitches
1 thread changes; 1 colors

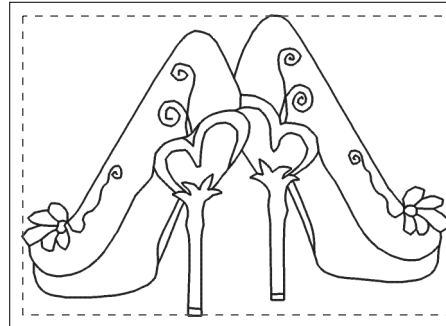

■ 1. Black

14 5x7.pes

6.67x4.69 inches; 4,006 stitches
1 thread changes; 1 colors

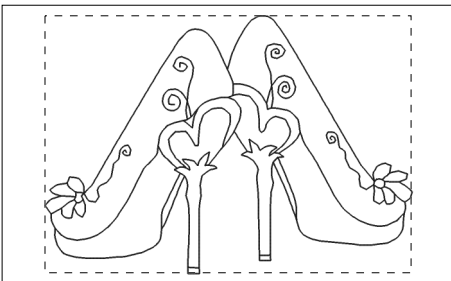

■ 1. Black

14 6x10.pes

8.29x5.82 inches; 4,890 stitches
1 thread changes; 1 colors

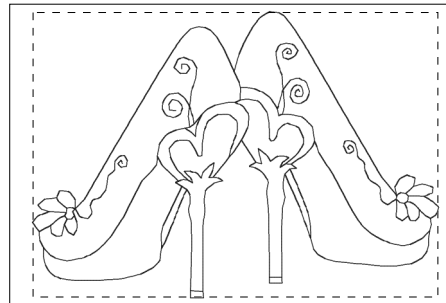

■ 1. Black (Bro:900)

14 8x12.pes

10.59x7.44 inches; 6,162 stitches
1 thread changes; 1 colors

Enjoy this fun set of shoes. These sew out very quickly in Bean Stitch. These would be really pretty in vairaged or metallic threads. This set would be great on any project, especially on shopping bags.

E:\00 SWAK EMBROIDERY FILES\EO321 and EO322 These shoes-boots are made for walking\EO322.These.Shoes.Are.Made.for.Walking.pes

Printed 2/4/2020

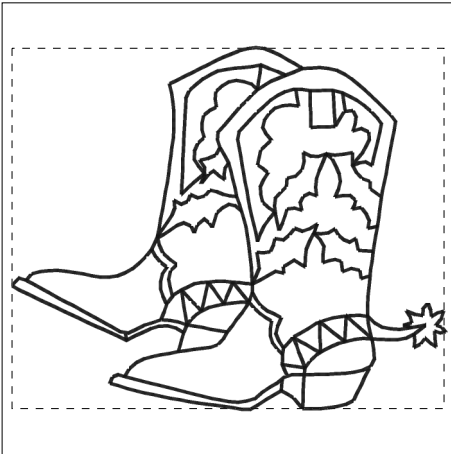

■ 1. Black

15 4x4.pes

3.76x3.14 inches; 2,994 stitches
1 thread changes; 1 colors

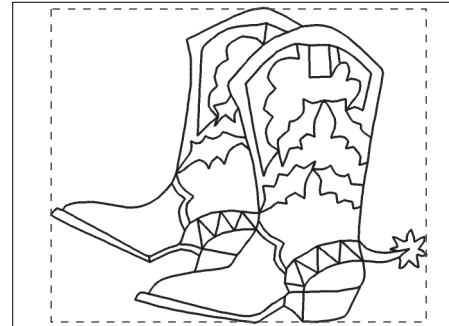

■ 1. Black

15 5x7.pes

5.88x4.91 inches; 4,506 stitches
1 thread changes; 1 colors

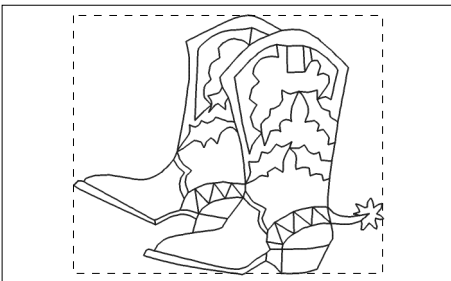

■ 1. Black

15 6x10.pes

7.00x5.85 inches; 5,302 stitches
1 thread changes; 1 colors

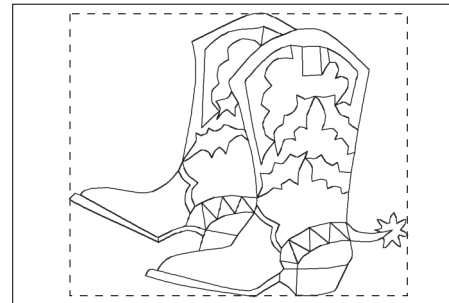

■ 1. Black (Bro:900)

15 8x12.pes

8.82x7.37 inches; 6,582 stitches
1 thread changes; 1 colors

Enjoy this fun set of shoes. These sew out very quickly in Bean Stitch. These would be really pretty in vairaged or metallic threads. This set would be great on any project, especially on shopping bags.

E:\00 SWAK EMBROIDERY FILES\EO321 and EO322 These shoes-boots are made for walking\EO322.These.Shoes.Are.Made.for.Walking.pes

Printed 2/4/2020

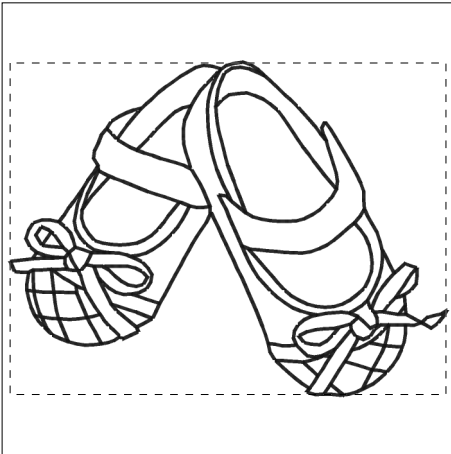

■ 1. Black

16 4x4.pes

3.80x2.89 inches; 2,866 stitches
1 thread changes; 1 colors

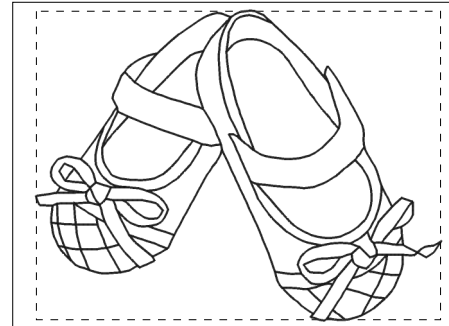

■ 1. Black

16 5x7.pes

6.34x4.84 inches; 4,606 stitches
1 thread changes; 1 colors

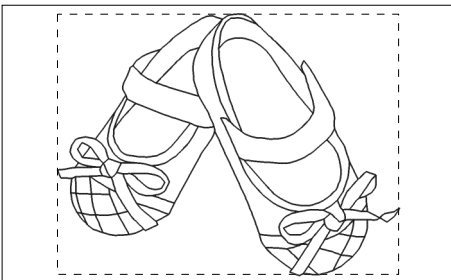

■ 1. Black

16 6x10.pes

7.72x5.90 inches; 5,550 stitches
1 thread changes; 1 colors

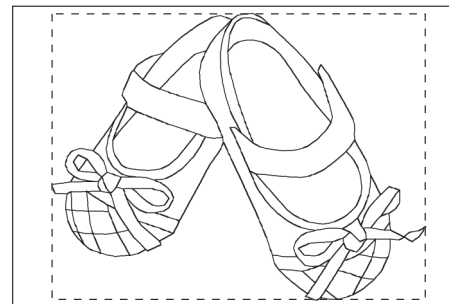

■ 1. Black (Bro:900)

16 8x12.pes

9.76x7.46 inches; 6,950 stitches
1 thread changes; 1 colors